

Cash Management

Fire Safes

Gun Safes

High Security Safes

Pharmacy Safes



ESL5

ESL10XL & ESL20XL

ESLAudit

SafeWizard II<sup>®</sup>

CashWizard II<sup>®</sup>



# TABLE OF CONTENTS



American Security Products Company has been dedicated to manufacturing high quality, high security safes since 1946. We offer an extensive product line of over 400 standard models of burglary and fire resistant safes in every insurance classification from "B" rate to Underwriter's Laboratories TL-15, TL-30 and TL-30x6.

AMSEC is the largest and most respected safe manufacturer in the industry because:

- Our dedicated Customer Service Representatives care about you.
- Fully staffed Technical Service Department networked with thousands of factory trained technicians.
- Our Quality Control Department assures that the products we build are the finest in the industry.
- State-of-the-art computer controlled manufacturing equipment helps us meet demanding deadlines and keeps us on the leading edge of technology.
- We are located in a major West Coast distribution point with direct access to all major domestic and international freight services.
- We specialize in developing custom safes to meet specific cash handling requirements for banks, restaurants, supermarkets, convenience stores and many other industries.
- Our Engineering and Design Department is fully staffed and features the most advanced CAD system for rapid creation of sales drawings, design modifications or precise manufacturing blue prints.

For superior asset protection there is only one name you can trust for quality, service and reliability...**AMSEC.**

*AMSEC reserves the right to incorporate any improvements and alter any specifications without prior notice. AMSEC reserves the right to update products as necessary, AMSEC is not responsible for typographical errors.*

<b>GUN SAFES</b>	
RF SERIES - HIGH SECURITY GUN SAFES	3
THE BF® SERIES GUN SAFES - 120 MINUTE FIRE	4
NF SERIES - 90 MINUTE FIRE	5
FV SERIES - 45 MINUTE FIRE	6
TF SERIES - THIRTY MINUTE FIRE	7
DEFENSE VAULT	8
VAULT DOOR VD8030NF / VD8030BF	8
HANDGUN SECURITY	9
<b>GUN SAFE ACCESSORIES</b>	10
<b>STORAGE OPTIONS</b>	10
STOR-IT CABINETS	10
PREMIUM DOOR ORGANIZER RETROFIT KITS	11
THE SAFE CLOAK	11
<b>BF® SERIES</b>	
U.L. LISTED FIRE RATED BURGLARY SAFES	12
<b>COMMERCIAL SECURITY SAFES</b>	
CSC SERIES COMPOSITE SAFES	13
AM SERIES HOME SECURITY SAFES	14
NEW! BFS912E5LP U.L. & ETL CERTIFIED BURGLARY & FIRE SAFE	14
<b>ELECTRONIC SECURITY SAFES</b>	15
IN-ROOM ELECTRONIC SAFES	15
ESF1214 FINGERPRINT SAFE	15
EST SERIES HOME SECURITY SAFES	15
U.L. LISTED 2-HOUR FIRE AND IMPACT SAFES	16
<b>IMPORTED U.L. LISTED 1-HR FIRE SAFES</b>	17
<b>WALL SAFES</b>	18
<b>FLOOR SAFES</b>	
BRUTE AND SUPER BRUTE	19
STAR® ROUND LIFT-OUT DOOR	20
MAJOR® ROUND LIFT-OUT DOOR	21
STAR® RECTANGULAR BODY, ROUND LIFT-OUT DOOR	21
<b>CASH MANAGEMENT SAFES</b>	
CASHWIZARD® BILL READER SAFES	22
RETAIL MONEY MANAGER SAFE	24
<b>DEPOSITORY SAFES</b>	
MONEY MANAGER SERIES	25
DS SERIES TILL STORAGE DEPOSITORY SAFES	25
BWB SERIES - WIDE BODY CASH CONTROL	26
BWB SERIES AND MS1414	27
DS SERIES - "B" RATE ROTARY AND FRONT LOADING	28
<b>UNDERCOUNTER SAFES</b>	29
<b>PHARMACY / NARCOTICS SAFES</b>	30
<b>AMVAULT TL-30 AND TL-15</b>	
ACF TL-30 FIRE RATED DEPOSITORY SAFE	31
AMVAULTX6 TL-30X6 HIGH SECURITY SAFE	31
AMVAULT FIRE RATED COMPOSITE SAFES	32
<b>TL-15 &amp; TL-30 MONEY CHESTS</b>	
DXE / DXF AND CDXE / CDXF U.L. LISTED	34
ACF TL-30 U.L. LISTED FIRE RATED MONEY CHEST	35
<b>"B" AND "C" RATE SECURITY CHESTS</b>	36
<b>TELLER LOCKERS</b>	37
<b>CUSTOM SAFES</b>	37
<b>OPTIONAL EXTRAS</b>	38
<b>ELECTRONIC LOCKS</b>	
AMSEC SAFEWIZARD II®	39
ESLAUDIT	40
ESL5 AND ESL15	40
AMSEC ESLXL SERIES	41
ROTOBOLT REDUNDANT SAFE LOCK	42
LOCKS FROM S&G, KABA AND LAGARD	42
ELECTRONIC LOCK COMPARISON CHART	43
<b>MECHANICAL LOCKS AND KEY LOCKS</b>	44
<b>MERCHANDISING / DISPLAYS</b>	45
<b>GUIDE TO SAFE USAGE</b>	46
<b>INDEX BY MODEL NUMBER</b>	47



# RF SERIES - HIGH SECURITY GUN SAFES

GUN SAFES

## RF703620X6 & RF582820X6



AMSEC offers the only gun safes that have a TL-30 UL Burglary Rating. To earn a TL-30 UL Burglary Rating, these safes are subjected to a brutal 30-minute attack by trained technicians using tools such as sledge hammers, picks, chisels, circular saws, carbide drills, wedges, and pry bars. These safes are the industry standard for protecting assets against the threat of serious attack.

The high level of security of these safe comes from AMSEC's unique composite construction. High-strength concrete with proprietary aggregate combined with a matrix of formed steel barriers stop types of attacks outlined in the Underwriters Laboratories standard. With a door thickness of 6 inches and a body thickness of 3 inches, these massive safes weigh between 3,400 and 4,500 pounds. No one is walking out of your house with one of these.

This is the same safe construction that AMSEC sells to banks and jewelers across the county. Today there are hundreds of millions of dollars' worth of assets protected by AMSEC TL-30 safes.

### SECURITY

- 6" Thick High Security Composite Door
- 3-1/2" Thick High Security Body (3" on X6)
- UL Listed TL-30 or TL-30X6 High Security Burglary Classification
- 10 Massive 1 1/2" Chrome Plated Bolts
- 4 Pre-Cut Anchor Holes

### FIRE PROTECTION

- Seamless High Security Composite Fill
- 120-Minute Certified Fire Rating
- Palusol Door Seal Protects Against Fire

### FUNCTIONALITY

- Industry's Most Flexible Interior
- Door Organizer
- Storage for Two Long Guns or Assault Rifles on Door

## RF6528



### INTERIORS FOR RFX SERIES:

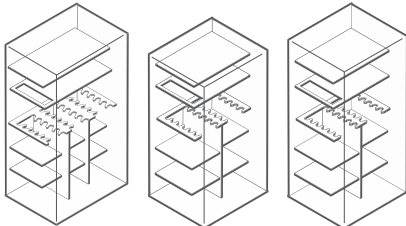

RF703620X6 RF582820X6 RF6528



### COLOR OPTIONS FOR RF SERIES SAFES:

#### High-Gloss Exterior Colors:

Burgundy Metallic (BY), Pearl Essence (PE), Platinum Metallic (PL), Charcoal Metallic (CM), Macadamia Metallic (MM), Onyx (OX), Rosso Corsa Red (RC), Sapphire Blue (SB)

#### Textured Exterior Colors:

Granite (GR), Sandstone (ST), Black (BK), Chocolate Brown (CB)

Model	Outside Dimension H x W x D	Thickness (Inches)		Interior Capacity	Wt. Lbs.
		Door	Body		
RF703620X6	76" x 42" x 29 1/4"	6"	3"	12-12-12-24-36 Gun 58 + 2 Gun	4,578
RF582820X6	64" x 34" x 29 1/4"	6"	3"	12-12-24 Gun + 2 Gun	3,418
RF6528	72" x 35" x 29 1/2"	6"	3-1/2"	12-12-24 Gun + 2 Gun	3,455

## GUN SAFE FIRE AND BURGLARY PROTECTION

American Security Products Co. is highly acclaimed for offering the industry's best fire protection. We manufacture the industry's broadest gamut of fire-rated products ranging from Underwriters Laboratories (U.L.) Listed 1 and 2 hour fire safes to our Intertek laboratory tested 2 hr., 90 minute, 45 minute and 30 minute fire protected gun safes.

Each safe is designed to maintain an interior temperature less than 350°F.

Paper products will char at approximately 450°F.

Series	Fire Label	Outside Temp	Time Period	Inside Temp Less Than
RFX Series	120 Minute	1850°F	120 min.	350°F
BF® Series	ETL 120 Minute	1200°F	120 min.	350°F
NF Series	ETL 90 Minute	1200°F	90 min.	350°F
FV Series	ETL 45 Minute	1200°F	45 min.	350°F
TF Series	30 Minute	1200°F	30 min.	350°F

THE BF® SERIES GUN SAFES - 120 MINUTE FIRE



BF7240

Shown with Optional Stor-it Cabinets and LED Light Kit

ETL-Intertek laboratory testing confirms that AMSEC's BF® Gun Safes have superior fire protection for two hours at 1,200°F. AMSEC's BF Gun Safes use a proprietary fill material called DryLight, which offers exceptional fire protection without adding excess weight. This superior fire protection was confirmed at ETL-Intertek, the industry's leading independent laboratory for gun safe fire testing. When analyzing the fire performance of competitive safes, be sure to weigh reports from independent laboratories against unverified factory testing or un-tested claims.

SECURITY

Door

- 1/2"-Thick Steel Plate Door (BF7250 & BF6024 have 3/8" steel plate)
- Three-Way Bolt Work
- UL Residential Security Container Burglary Classification
- 12 massive 1-1/2" Chrome Plated Bolts
- **Optional Redundant Boltwork Available**
  - Two installed locks operate completely independently
  - Either lock allows access to safe
  - Protects against any type of lock failure
  - Available on standard and HD models

Body

- 2" double wall steel construction
- Standard total steel thickness 1/4"
- HD series total steel thickness 3/8"
- 4 pre-cut anchor holes

FIRE PROTECTION

- Seamless DryLight Fill
- 120-Minute Intertek Verified Fire Rating
- Dual Door Seals to Protect Against Fire and Smoke

FUNCTIONALITY

- Industry's Most Flexible Interior
- Door Organizer
- Storage for Two Long Guns or Assault Rifles on Door
- Mirrored Back for Added Interior Visibility
- AC Power Outlet



Model	Outside Dimension H x W x D	Thickness (Inches)		Interior Capacity	Wt. Lbs.^
		Door Overall / Steel plate	Body		
BF7250	71-1/4" x 50" x 28"	4 <sup>5</sup> / <sub>8</sub> / 3/8"	2	14-14-14-28-42 + 2 Gun	1,789
BF7250HD	71-1/4" x 50" x 28"			73 + 2 Gun	2,204
BF7240	71-1/4" x 40" x 26"	4 <sup>3</sup> / <sub>4</sub> / 1/2"	2	12-12-12-24-36 + 2 Gun	1,585
BF7240HD	71-1/4" x 40" x 26"			58 + 2 Gun	1,923
BF6636	65-1/4" x 36" x 26"	4 <sup>3</sup> / <sub>4</sub> / 1/2"	2	12-12-24 + 2 Gun	1,319
BF6636HD	65-1/4" x 36" x 26"				1,601
BF6030	59-1/4" x 30" x 26"	4 <sup>3</sup> / <sub>4</sub> / 1/2"	2	11-11-22 + 2 Gun	1,036
BF6030HD	59-1/4" x 30" x 26"				1,244
BF6032	59-1/4" x 30" x 21"	4 <sup>3</sup> / <sub>4</sub> / 1/2"	2	9-9-18 + 2 Gun	913
BF6032HD	59-1/4" x 30" x 21"				1,118
BF6024	59-1/4" x 24" x 21"	4 <sup>5</sup> / <sub>8</sub> / 3/8"	2	8-8-16 Gun + 1 Gun	720
BF6024HD	59-1/4" x 24" x 21"				893

COLOR OPTIONS:

**High-Gloss Exterior Colors:**  
Burgundy Metallic (BY), Pearl Essence (PE), Platinum Metallic (PL), Charcoal Metallic (CM), Macadamia Metallic (MM), Onyx (OX), Rosso Corsa Red (RC), Sapphire Blue (SB)

**Textured Exterior Colors:**  
Granite (GR), Sandstone (ST), Black (BK), Chocolate Brown (CB)

**Two-Tone Finishes:**  
Onyx High-gloss door / Black Textured body or Charcoal Metallic High-gloss door / Granite Textured body

**Any combination available on request**

*Dimensions listed are exterior dimensions. Add 2-7/8" on all BF safes to overall depth for lock and handle.*

*^ Add 5lbs for Redundant Boltwork option.*

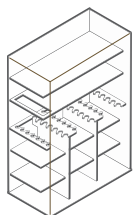

BF7250 STANDARD GUN INTERIOR

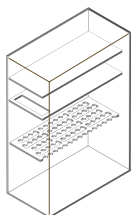

BF7250 73 GUN INTERIOR

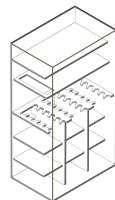

BF7240 STANDARD GUN INTERIOR

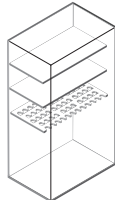

BF7240 58 GUN INTERIOR

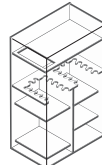

BF6636 STANDARD GUN INTERIOR

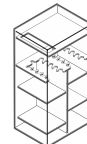

BF6030 STANDARD GUN INTERIOR

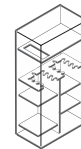

BF6032 STANDARD GUN INTERIOR

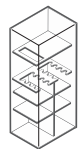

BF6024 STANDARD GUN INTERIOR



**NF SERIES - 90 MINUTE FIRE**

**GUN SAFES**

The American Security Products NF Gun Safe offers both superior performance and value. For burglary protection, it has a stout ¼"-thick steel plate in the door. For fire protection, it is lined with 3 layers of drywall that are strategically engineered for optimal fire protection. This enables the NF Gun Safe to pass a verified 90-minute fire test at Intertek, an independent testing laboratory.



**NF6030**

**SECURITY**

- ¼"-Thick Steel Plate Door
- Four-Way Bolt Work
- 11-Gauge Steel Body
- UL Residential Security Container Burglary Classification
- 14 Massive 1½" Chrome Plated Bolts
- 4 Pre-Cut Anchor Holes

**FIRE PROTECTION**

- Lined with Three Layers of Drywall (4 on top and bottom)
- 90-Minute Intertek Verified Fire Rating
- Dual Door Seals to Protect Against Fire and Smoke

**FUNCTIONALITY**

- Industry's Most Flexible Interior
- Door Organizer
- Storage for Two Long Guns or Assault Rifles on Door (One on NF5924)
- AC Power Outlet



**NF6030 WITH NEW STANDARD STOR-IT PDO AND OPTIONAL STOR-IT CABINETS**

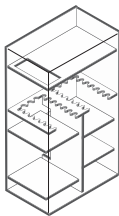

**NF6036/NF6036E5  
STANDARD  
GUN INTERIOR**

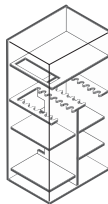

**NF6030/NF6030E5  
STANDARD  
GUN INTERIOR**

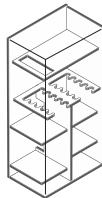

**NF6032/NF6032E5  
STANDARD  
GUN INTERIOR**

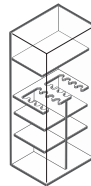

**NF5924/NF5924E5  
STANDARD  
GUN INTERIOR**

**COLOR OPTIONS:**

**High-Gloss Exterior Colors:**

Burgundy Metallic (BY), Pearl Essence (PE), Platinum Metallic (PL), Charcoal Metallic (CM), Macadamia Metallic (MM), Onyx (OX), Rosso Corsa Red (RC), Sapphire Blue (SB)

**Textured Exterior Colors:**

Granite (GR), Sandstone (ST), Black (BK), Chocolate Brown (CB)

**Two-Tone Finishes:**

Onyx High-gloss door / Black Textured body or Charcoal Metallic High-gloss door / Granite Textured body

**Any combination available on request**

**NFE5 SERIES**

**STANDARD COLOR:**

Textured Black (BK) with Black Nickel Hardware (LTN)

Model	Outside Dimension H x W x D	Thickness (Inches)		Interior Capacity	Wt. Lbs.
		Door Overall / Steel plate	Body		
NF6036 / NF6036E5	59" x 36" x 26"	4 ¼ / ¼"	11 ga	17-17-34 + 2 Gun	977
NF6030 / NF6030E5	59" x 30" x 26"	4 ¼ / ¼"	11 ga	14-14-28 + 2 Gun	854
NF6032 / NF6032E5	59" x 30" x 21"	4 ¼ / ¼"	11 ga	9-9-18 + 2 Gun	761
NF5924 / NF5924E5	59" x 24" x 18"	4 ¼ / ¼"	11 ga	8-8-16 Gun + 1 Gun	600

Dimensions listed are exterior dimensions. Add 2-7/8" to overall depth for lock and handle.

# FV SERIES - 45 MINUTE FIRE



The American Security Products FV gun safe offers both performance and value. For burglary protection, it has a stout 3/16" - thick steel plate in the door. For fire protection, it is lined with 2 layers of drywall that are strategically engineered for optimal fire protection. This enables the FV Gun Safe to pass a verified 45-minute fire test at Intertek, an independent testing laboratory.



FV7240E5



FV6030E5 WITH STOR-IT PDO

## SECURITY

- 3/16"-Thick Steel Plate Door
- Four-Way Bolt Work
- 12-Gauge steel body
- (14) 1 1/4" Chrome Plated Bolts
- 4 Pre-Cut Anchor Holes

## FIRE PROTECTION

- Lined with two layers of drywall
- 45-Minute Intertek Verified Fire Rating
- Dual Door Seals to Protect Against Fire and Smoke

## FUNCTIONALITY

- U.L. Listed ESL5 Electronic Lock with Illuminated Keypad
- Industry's Most Flexible Interior
- Door Organizer
- Storage for Two Long Guns or Assault Rifles on Door
- One electrical access hole

Model	Outside Dimension H x W x D	Thickness (Inches)		Interior Capacity	Wt. Lbs.
		Door Overall / Steel plate	Body		
FV7240E5	72" x 40" x 26"	3 5/8" / 3/16"	12 ga	15-15-15-30-45 + 2 Gun	954
FV6036E5	59" x 36" x 26"	3 5/8" / 3/16"	12 ga	17-17-34 + 2 Gun	724
FV6030E5	59" x 30" x 26"	3 5/8" / 3/16"	12 ga	15-15-30 + 2 Gun	608
FV6032E5	59" x 30" x 21"	3 5/8" / 3/16"	12 ga	11-11-22 + 2 Gun	578



## EXTERIOR COLOR:

Black (BK)

Dimensions listed are exterior dimensions. Add 2" to overall depth for lock and handle.

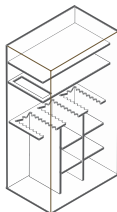

**15-15-5-30-45  
GUN INTERIOR**  
for Model: FV7240E5

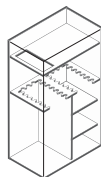

**17-17-34  
GUN INTERIOR**  
for Model: FV6036E5

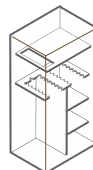

**15-15-30  
GUN INTERIOR**  
for Model: FV6030E5

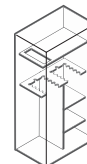

**11-11-22  
GUN INTERIOR**  
for Model: FV6032E5



**TF SERIES - THIRTY MINUTE FIRE**

**GUN SAFES**



**TF5924E5**



**TF5517E5**

**TF5924E5**

**SECURITY**

- 3/16"-Thick Steel Plate Door
- Four-Way Bolt Work
- 14-Gauge Steel Body
- (14) 1 1/4" Chrome Plated Bolts
- 4 Pre-Cut Anchor Holes

**FIRE PROTECTION**

- Lined with Two Layers of Drywall on the Ceiling and Door
- Lined with One Layer of Drywall in All the Walls
- 30-Minute Fire Protection
- Dual Door Seals to Protect Against Fire and Smoke

**FUNCTIONALITY**

- U.L. Listed ESL5 Electronic Lock with Illuminated Keypad
- Industry's Most Flexible Interior
- Door Organizer
- Storage for One Long Gun or One Assault Rifle on the Door
- One electrical access hole



**TF5517E5**

**SECURITY**

- 3/16"-Thick Steel Plate Door
- Four-Way Bolt Work
- 14-Gauge Steel Body
- (8) 1" Chrome Plated Bolts
- 4 Pre-Cut Anchor Holes

**FIRE PROTECTION**

- Lined with Two Layers of Drywall on the Ceiling and Door
- Lined with One Layer of Drywall in All the Walls
- 30-Minute Fire Protection
- Dual Door Seals to Protect Against Fire and Smoke

**FUNCTIONALITY**

- U.L. Listed ESL5 Electronic Lock with Illuminated Keypad
- Industry's Most Flexible Interior
- Door Organizer
- One electrical access hole



Model	Outside Dimension H x W x D	Thickness (Inches)		Interior Capacity	Wt. Lbs.
		Door Overall / Steel plate	Body		
TF5924E5	59" x 24" x 18"	3 5/8" / 3/16"	14 ga	8-8-16 Gun + 1 Gun	388
TF5517E5	55-1/4" x 17-3/4" x 16"	3 1/4" / 3/16"	14 ga	11 Gun	286

Dimensions listed are exterior dimensions. Add 2" to overall depth for lock and handle.

**EXTERIOR COLOR:**

Black (BK)

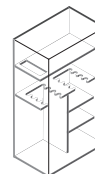

**8-8-16 GUN INTERIOR**  
TF5924E5

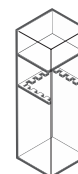

**11 GUN INTERIOR**  
TF5517E5

DEFENSE VAULT

## DEFENSE VAULT



AMSEC's DV652 was produced from our culture of listening to customers. Customers wanted a secure place to store their home defense weapons. Sleek enough to fit under most beds, the DV652 can be secured to either the floor or the bed and is equipped with our backlit ESL5 lock, which offers a stealth-mode option and was specifically designed for this product.

### Features

- Foam Padded Slide-Out Gun Tray
- Electronic Lock with Backlit Keypad
- 14-Gauge Steel Construction
- 5-Point Locking Bar
- 4 Mounting Holes on Both the Top and Bottom



Model	Outside Dimension H x W x D	Wt. Lbs.
DV652	6" x 52" x 14"	90
Tray Size	3 3/8" x 43 1/4" x 13"	

VAULT DOOR

## VAULT DOOR VD8030NF / VD8030BF



VD8030NF

### Turn Your Entire Room Into a Security Center

AMSEC Vault Doors offer the same protection as our innovative BF and NF Gun Safes. They are designed to fit standard 80" x 30" and 80" x 36" door openings. With our inward-swing vault door option, your vault room can also serve as a storm shelter. The vault door's inward swing ensures that you will be able to open the door even if debris has fallen on the other side. All AMSEC vault doors can be opened from the inside, ensuring personal safety.

#### Standard Features

- 2" Thick Door
- (10) 1 1/2" Chrome Plated Bolts
- Adjustable Frame to Fit Walls Ranging From 4 3/4" to 9 1/2" Thick
- Safety Lock Release
- Dual Door Seals to Protect Against Fire and Smoke

#### NF Series

#### Vault Door Features

- 3/8" Thick Steel Plate Door
- Three Layers of Drywall

#### BF Series

#### Vault Door Features

- 1/2" Steel Plate on Face of Door
- 1" of Seamless Drylight as Fire Protection

VD8030BF/VD8030NF



VD8030BF



VD8030NF

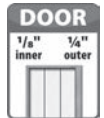

Model	Description	Wall Opening	Door Opening	Weight (Door Only)	Shipping Weight
VD8030NF	Vault Door	79-1/2" x 29-1/2"	77-1/2" x 24-3/4"	523	667
VD8030NFIS	In-Swing Vault Door	79-1/2" x 29-1/2"	77" x 20-3/8"	505	649
VD8036NF	Vault Door	79-1/2" x 35-1/2"	77-1/2" x 31"	612	782
VD8036NFIS	In-Swing Vault Door	79-1/2" x 35-1/2"	77" x 26-1/4"	575	745
VD8030BF	Vault Door	79-1/2" x 29-1/2"	77-1/2" x 24-3/4"	695	839
VD8030BFIS	In-Swing Vault Door	79-1/2" x 29-1/2"	77" x 20-3/8"	672	816
VD8036BF	Vault Door	79-1/2" x 35-1/2"	77-1/2" x 31"	819	989
VD8036BFIS	In-Swing Vault Door	79-1/2" x 35-1/2"	77" x 26-1/4"	792	962

### COLOR OPTIONS FOR VAULT DOOR SERIES SAFES:

Granite (GR), Sandstone (ST), Black (BK), Chocolate Brown (CB)





**HANDGUN SECURITY**

HANDGUN SECURITY



	<b>PS1210HD</b>	<b>PS1210EZ</b>	<b>PB3</b>	<b>HAS410</b>
	<b>BEST</b>	<b>BETTER</b>	<b>GOOD</b>	<b>BEST</b>
<b>Type</b>	Portable	Portable	Portable	Hide-a-Safe
<b>Exterior Dimension</b>	10.25" x 12.5" x 4.25"	10.25" x 12.5" x 4.25"	12" x 8" x 4"	12" x 10" x 4"
<b>Weight</b>	24 Lbs.	13 Lbs.	10 Lbs.	24 Lbs.
<b>Body</b>	10 ga. Solid Steel	14 ga. Solid Steel	16 ga. Solid Steel	10 ga. Solid Steel
<b>Door</b>	3/16" Solid Steel	14 ga. Solid Steel	16 ga. Solid Steel	3/16" Solid Steel
<b>Lock</b>	Simplex Mechanical Push Button	Simplex Mechanical Push Button	E-Lock (4) AA Batteries	Simplex Mechanical Push Button
<b>Locking Bolt</b>	1.5" x .5" Solid Steel Block	1.5" x .5" Solid Steel Block	.32" Round Solid Steel	1.5" x .5" Solid Steel Block
<b>Lock Protection</b>	Solid Steel Lock Housing	Solid Steel Lock Housing	N/A	Solid Steel Lock Housing
<b>Interior</b>	High Density Pluck Foam	High Density Pluck Foam	High Density Foam	High Density Pluck Foam
<b>Finish</b>	Granite Textured	Charcoal Gray	Deep Blue Textured	Charcoal Gray
<b>Carry Handle</b>	Chrome Plated Collapsible	Chrome Plated Collapsible	Chrome Plated Collapsible	Solid Steel Fixed
<b>Anchor Holes</b>	Four	Four	Two	Four (Top & Bottom)
<b>Origin</b>	Made in the USA	China	China	China



**IRC412  
Drawer Safe**

**Safe Features**

- Heavy-duty steel construction offers excellent burglary protection
- Motorized locking system
- LED display
- 4- to 6-digit combination, standard hotel room configuration
- Fits in a drawer and only requires 5" clearance
- Spacious interior can fit tablets and compact laptop computers

<b>Exterior Dimensions</b>	<b>Weight</b>
4.5 h x 12 w x 14d	15 lbs



## GUN SAFE ACCESSORIES AND OPTIONS



### BATTERY OPERATED LIGHT KIT

This light fits any safe, yet gives off a super bright light, letting you see the contents of your safe easily. Battery operated.



### PISTOL DRAWER

This slide-out handgun drawer has slide-in adjustable dividers that provides greater custom storage and organization. Fits models 6030 and larger.



### .50 CALIBER HANDLE

5-Spoke handle. Available in Black Nickel.



### LED LIGHT KITS

Has two 36" light strips with high-intensity white LED lights and a motion sensor that automatically turns the lights on when motion is detected. The lights turn off 30 seconds after motion has stopped. This light kit can be installed on any AMSEC safe and is also available as a retrofit kit.

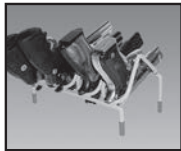

### PISTOL RACK

Ideal for organizing pistols inside your safe. This four gun pistol rack sits on top of an interior shelf.



### GUNSAVER DEHUMIDIFIER

Will constantly guard your guns against the threat of rust, pitting and moisture damage. Electrical access is required.



### "AR" RACK

"AR" gun racks are fully adjustable and custom fit in the side shelf area of each "BF" series gun safe. Each rack is designed with enough clearance to accommodate extra large front sights or optics.



### JEWELRY DRAWER

Velvet lined jewelry drawer that can be installed on top or underneath most shelves.



Small Drawer:  
7" x 11½" x 3⅝"

Large Drawer:  
10" x 13⅓" x 3⅝"



### DESSICANT

Prevents rust and moisture damage. Recommended for safes without electrical access.

### PREMIUM UPGRADE PACKAGE FOR RF, BF® AND NF SAFES

When you choose to upgrade your American Security RF, BF® or NF Series with a Premium Package, we'll add on some of our most popular options, including the GunSaver Dehumidifier, a Jewelry Drawer, an LED light kit, and a 3-outlet power strip with USB, or internal power strip.

## STOR-IT CABINETS

### Stor-it Cabinets

These elegant, well-appointed **2-DRAWER AND 4-DRAWER INTERIOR CHESTS** are finely crafted in solid-wood maple drawer fronts and maple veneer and finished in a rich honey maple stain. Recessed door pulls give these cabinets a more streamlined appearance and makes for an easier fit into a variety of AMSEC safes. All drawers are elegantly lined in a silky, dark red felt with heavy-duty, ball-bearing drawer glides and include a variety of Stor-It Jewelry Organizer Inserts. Each insert can be removed for easy viewing, selecting and protection of your jewelry.

#### 2-DRAWER OPTION:

- Top drawer includes a Three Compartment Ring Organizer and a Seven Compartment Jewelry Organizer. Bottom drawer can be used for bulky items or converts to a file drawer.
- Outside Dimensions: 16-1/2" x 15-7/8" x 14"
- Weight: 28 lbs.



#### 4-DRAWER OPTION:

- Top drawer features a three compartment ring organizer and a seven compartment jewelry organizer. Drawer two features a three compartment necklace organizer. Drawer three features a four compartment watch organizer. Drawer four can be used for bulky items.
- Outside Dimensions: 16-1/2" x 15-7/8" x 14"
- Weight: 29 lbs.

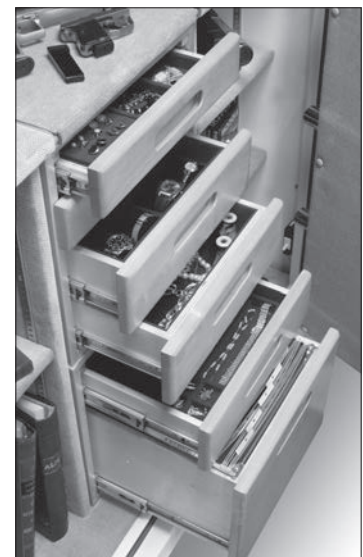

#### AVAILABLE IN THE FOLOWING SAFE MODELS:

**GUN SAFES:** RF6528, RF703620X6, RF582820X6, BF7250\*, BF7240, BF6636, BF6030, NF6036 and NF6030

**BURGLARY/FIRE SAFES:** BF1716\* / BF3416\*

**CE AND CF MODELS:** 2518\* / 3524\* / 5524\* / 6528\* / 7236\*

**CSC MODELS:** CSC3018\* AND CSC4520\*

\* No kit needed. Cabinets slide right in.



## PREMIUM DOOR ORGANIZER RETROFIT KITS

STORAGE OPTIONS

The AMSEC Premium Door Organizer (PDO) maximizes storage space, offers quick access to commonly used items, and are easily installed on any gun safe.

**All PDO's include:**

- Various see-through pouches and zippered pockets to store valuables.
- Two rows of holders for storage of choke tubes, small flashlights and ammo.
- Two full-width pistol storage systems to accommodate multiple handguns. Comes with four holsters. Additional holsters can be purchased separately.
- A long gun storage system that accommodates two guns. Includes the AMSEC exclusive "no hassle" quick release band.
- PDO Model 28 offers a zippered pocket large enough to store letter-size folders.



**PDO Model 13**  
Fits safe doors up to 48.5"H x 19"W.



**PDO Model 19**  
Fits safe doors up to 51.25"H x 25"W.  
With included extension strap kit, fits safe doors up to 57.75"H x 34"W.



**PDO Model 28**  
Fits safe doors up to 64"H x 34"W. With included extension strap kit, fits safe doors up to 70.5"H x 40"W.

THE SAFE CLOAK

## THE SAFE CLOAK



### Hide Your Gun Safe In Plain Sight!

Instantly disguise your gun safe with Amsec's Safe Cloak. Available in five different sizes, the Safe Cloak fits over your gun safe to instantly disguise it as a wood cabinet. Strong magnets and a sewn-in PVC board at the top easily and securely hold the cloak in place. The thermal-transfer, four-color wood-cabinet print is so good, it will fool not only passersby, but guests as well.

Available in the following sizes:  
6024, 6030, 6636, 7240, 7250.

# U.L. LISTED FIRE RATED BURGLARY SAFES



The AMSEC **BF® SERIES** offers a unique design that combines all the security features of a burglary safe and the peace of mind achieved with a fire safe. The industry's first U.L. Listed, fire-rated burglary safe offers an affordable solution when burglary and fire protection are an essential part of your buying decision!

During Underwriter's Laboratories grueling testing procedures, the **BF® SERIES** earned the U.L. Listed Class 350°F One Hour Fire Label and the (RSC) Residential Security Container Burglary Label.



BF2116 W/ESL10XL



BF1512 W/ESL10XL

## FEATURES

- The best warranty in the business. Lifetime fire replacement and one year parts and labor.
- U.L. 1-Hr. 350°F fire rating. Tested at temperatures up to 1700°F

### Door:

- 3½" thick, consisting of ½" plate steel with a unique proprietary fire and burglary resistant material.
- Dual seal design utilizes a silicone foam seal with a heat-expanding Palusol intumescent seal.
- U.L. listed Group II lock with spring-loaded auxiliary relock device.
- ¼" heavy duty carburized hardplate.

### Body:

- 2⅝" thick, consisting of ⅛" outer and inner steel plates creating a burglary resistant structure enclosing a unique proprietary fire resistant material.
- Three massive 1" diameter solid steel chrome-plated locking bolts.

- A full length dead bar locks deep into the body preventing door removal during a forced entry attempt.
- Heavy duty steel hinges provide easy smooth door operation.
- One recessed anchor bolt hole and mounting hardware are provided to securely anchor safe.
- Plush velour interior.
- Attractively accented with a brass, chrome or black nickel handle and decorative emblems.
- Available in several durable and attractive textured or high gloss finishes.
- Optional electronic locks are available. **SEE PAGES 40-42.**
- Optional storage cabinets available on models BF3416 and BF1716. **SEE PAGE 10.**



**OPTIONAL LED LIGHT KIT WITH MOTION SENSOR AVAILABLE FOR ALL MODELS. SEE PAGE 12 FOR DETAILS.**

### BF® Safes Lifetime Replacement Warranty:

If your BF® safe is exposed to fire and failed to protect the contents, your BF® safe will be replaced free of charge. Just return the safe freight prepaid to the factory accompanied with the fire report. Contact your dealer for further details.

Palusol®

### INTUMESCENT DOOR SEAL:

When the intumescent seal is exposed to high temperature (above 250°F), it expands to as much as 8 times its original thickness. In this expanded or reactive state, it has very high thermal insulating capacity and resistance to breakdown. This provides a strong positive seal between the door and body, preventing heat influx.

Model	Inside Dim H x W x D	Outside Dim <sup>^</sup> H x W x D	Clear Door H x W	Cu. In.	Wt	Shelves
BF1512	15 x 12 x 13	20-1/4 x 17-1/4 x 18-3/4	15 x 12	2,340	288	1
BF1716	17 x 16½ x 16	22-1/4 x 21-3/4 x 21-3/4	17 x 16½	4,488	412	1
BF2116	21 x 16½ x 14½	26-1/4 x 21-3/4 x 20-1/4	21 x 16½	5,024	476	1
BF3416 †	34 x 16½ x 16	39-1/4 x 21-3/4 x 21-3/4	34 x 16½	8,976	690	2

BOLT DOWN KIT INCLUDED, <sup>^</sup>ADD 2" FOR DIAL & HANDLE, † 1/2 hour U.L. Fire Rating

**High-Gloss Exterior Color Options:** Burgundy Metallic (BY), Pearl Essence (PE), Platinum Metallic (PL), Charcoal Metallic (CM), Macadamia Metallic (MM), Onyx (OX), Rosso Corsa Red (RC), Sapphire Blue (SB) **Textured Exterior Color Options:** Granite (GR), Sandstone (ST), Black (BK), Chocolate Brown (CB)



**CSC SERIES COMPOSITE SAFES**

COMMERCIAL SECURITY SAFES

AMSEC **CSC SERIES COMPOSITE SAFES** are an affordable solution when you want to protect both documents from fire and valuables from burglary attacks. During extreme testing procedures the **CSC SERIES COMPOSITE** safes passed a 2-Hour, 350°F factory fire test certification.



*Interior temperature less than 350°F for a period of 2 hours at 1700°F*



**CSC4520**



**CSC3018 WITH  
OPTIONAL STOR-IT CABINET**



**CSC1913**

**Features:**

**Door:**

- Overall thickness of 4-5/8" and is constructed with a 2" defense barrier of outer and inner steel plates creating a burglary resistant structure enclosing a unique proprietary, fire resistant material.

**Body:**

- 2-7/8" double wall steel construction enclosing a unique, high-density fire and burglary resistant composite material.
- Durable powder coated adjustable shelves.
- Removable casters provide easy delivery and installation.

**Fire Endurance:**

- 2 hour, 350°F factory fire rating. Tested at temperatures up to 1700°F.
- Heat expandable intumescent door seal guards contents against severe fires.

**Locking Mechanism:**

- Two to four 1 1/2" diameter solid steel chrome-plated locking bolts.
- Two to three 1 1/2" diameter solid steel dead bolts lock deep into body preventing door removal during a forced entry attempt.
- U.L. Listed Group II combination lock with chrome-plated spy-proof dial. Optional electronic locks available.
- Lock protected by a tempered glass relock device.
- Heavy duty steel hinges provide easy, smooth door operation.
- One internal counter-sunk anchor hole and mounting hardware are provided to securely anchor safe.
- Attractively accented with a full width facia panel and matching three point handle,
- Durable and attractive charcoal gray textured finish.



**CSC1413**

**OPTIONAL STORAGE CABINETS AVAILABLE IN MODELS CSC3018 AND CSC4520. NO KIT NEEDED, DRAWERS SLIDE RIGHT IN. SEE PAGE 10 FOR MORE DETAILS**

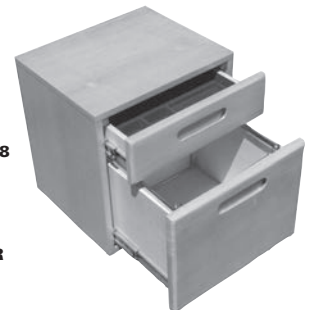

Model	Inside Dim H x W x D	Outside Dim* H x W x D	Cu. In.	Wt	Shelves	Rubber Feet or Casters
CSC1413	14 x 12-1/2 x 12-1/4	19-1/2 x 18 x 19-7/8	2,135	256	1	Rubber Feet
CSC1913	19 x 12-3/8 x 12	24-1/2 x 18 x 19-7/8	2,898	318	2	Rubber Feet
CSC3018	30 x 18 x 16-1/2	35-1/2 x 23-1/2 x 24	8,802	530	3	Casters
CSC4520	45 x 20 x 21-1/4	50-1/2 x 25-1/2 x 28-7/8	19,080	944	4	Casters

\* Add 2" to outside depth for handle, dial and hinge projection.

\* Add 4 1/4" (casters) and 1" (rubber feet) to outside height.



**OPTIONAL LED LIGHT KIT WITH MOTION SENSOR AVAILABLE FOR ALL MODELS. SEE PAGE 10 FOR DETAILS.**

AM SERIES HOME SECURITY SAFES



AM4020E5

FEATURES

- Powder-Coated Blue with Black Nickel Hardware
- Gray Fabric Interior
- Backlit U.L. Listed ESL5 Electronic Lock
- 12-Gauge Steel Body
- Drywall Lined
- 30-Minute Fire Rating
- Three-Way Bolt Work
- Electrical Access Hole
- 4 Pre-Cut Anchor Holes
- 1 Year Parts and Labor Warranty



Model	Outside H x W x D	Inside H x W x D	Cubic Inches	Thickness		Wt. Lbs.	Interior Shelves	Bolts
				Door	Body			
AM2020E5	20 x 20 x 20	17 x 18¼ x 14½	4,710	1½	12 ga	180	1	6
AM3020E5	30 x 20 x 20	27 x 18¼ x 14½	7,402	1½	12 ga	230	2	8
AM4020E5	40 x 20 x 20	37 x 18¼ x 14½	10,094	1½	12 ga	282	3	8

NEW! BFS912E5LP U.L. & ETL CERTIFIED BURGLARY & FIRE SAFE



The **BFS912E5LP** combines burglary and fire protection in a compact safe.

RATINGS

- ETL Verified Fire protection of 1775° F for 80 minutes
- U.L. Residential Security Container (RSC) Burglary classification

BODY

- 1-3/4" double wall steel construction
- 3/16" steel barrier
- Unique fire resistant barrier
- Interlock fire-safe jamb
- Two anchor holes with hardware

DOOR

- 3/8" solid steel plate
- Unique fire resistant barrier



- ESL5LP, U.L. Type 1 High Security electronic lock
  1. Illuminated keypad
  2. 15 min. penalty lockout
  3. One 9-volt battery
- Massive hardplate and two relock devices
- Three 3/8" x 1" steel locking bolts.
- Three 3/8" x 1" steel dead bolts.



Model	Inside Dimension H x W x D	Outside Dimension H x W x D	Clear Door	Cu. In. Capacity	Wt
BFS912E5LP	9 x 12-1/2 x 11	12-3/4 x 16-1/4 x 16-3/8	9 x 12-1/2	1,238	118



ELECTRONIC SECURITY SAFES

ELECTRONIC SECURITY SAFES

## EST SERIES HOME SECURITY SAFES



### FEATURES:

- DL5000 bounce-proof electronic lock with a large 3 3/4" touch screen LCD input display allows smooth and easy operation.
- Mode altering display changes from orange in standby mode to bright blue in the open position.
- Accepts (2) user codes and can show open door records for the past 14 entries.
- LCD touch screen display shows low-battery indicator, time, date and keypad.
- Emergency key-lock override system with two (2) keys, power override battery box, built-in spy-proof function and motion detector alert.
- Heavy 14 gauge solid steel construction, plus dual live bolts made also of heavy gauge steel.
- Can be bolted to the wall or floor.
- Carpeted base.
- Pry-resistant recessed door with internal hinges for anti-theft protection.
- Mounting feet and anchor hardware standard.
- Models EST1014 and EST2014 have one removable shelf.
- Warranty: 1 year parts and labor.

Model	Inside Dimension H x W x D	Outside Dimension H x W x D	Clear Door	Cu. In. Capacity	Wt
EST813	7-11/16 x 12-1/16 x 5-3/8	7-7/8 x 12-1/4 x 8	5-3/4 x 8-1/4	499	16
EST916	8-13/16 x 15-13/16 x 11-1/8	9 x 16 x 13-1/4	6-3/4 x 12-1/8	1,550	27
EST1014	9-9/16 x 13-15/16 x 7-3/4	9-3/4 x 14-1/8 x 9-3/4	7-5/8 x 10-1/4	1,032	22
EST2014	19-9/16 x 13-9/16 x 10	19-3/4 x 13-3/4 x 12-1/4	17-1/8 x 9-1/4	2,602	40

## IN-ROOM ELECTRONIC SAFES



AMSEC's **IN-ROOM ELECTRONIC SAFE**, with its easy installation, maintenance and management features has become a popular safe in the hospitality industry. Designed with the traveling guests in mind, the IRC916E will adequately secure laptop computers, cameras, jewelry and other valuables in the most user-friendly safe made.

### FEATURES:

- Heavy duty steel construction offers excellent burglary protection.
- Convenient motorized locking system, incorporating the latest technology.
- Easy to read, large LED display lets you know the status of the safe.
- 4 to 6 digit combination, standard hotel room configuration (customer sets new combination every time safe is used, quickly and easily), or electronic credit card.
- Reliable ADA approved keypad.
- Runs on 4 AA batteries. If batteries should go dead, each safe has a by-pass power cable.
- Lock-out penalty if the combination is entered wrong, the safe will lock up for 15 minutes, frustrating the would-be burglar.
- Emergency key-lock override system with 2 keys.
- Spacious interior fits most lap top computers.
- Two anchor holes with mounting hardware included.
- Attractive carpeted bottom hides anchor bolts.
- Electrostatic powder-coated finish in textured black.
- Guest instruction label included.
- Packaged for UPS shipment.



**ALSO AVAILABLE:  
THE IRC412  
DRAWER SAFE.  
SEE PAGE 9  
FOR MORE INFO**

Model	Inside Dimension H x W x D	Outside Dimension H x W x D	Clear Door	Cu. In. Capacity	Wt
IRC916E	8-13/16 x 15-13/16 x 12	9 x 16 x 14	6-9/16 x 13	1,672	29

## ESF1214 FINGERPRINT SAFE



### FEATURES:

- State-of-the-art fingerprint electronic lock.
- Motorized bolt work system with 2 chrome-plated solid-steel locking bolts.
- Spring-assisted door auto opens when unlocked.
- Laser-cut arched door design with heavy-duty 7/16" solid steel door and casing.
- 1/8" thick solid steel body.
- Attractive textured black finish.
- 1 adjustable shelf.
- Includes: 1 emergency key-lock with 2 keys and anchor kit.
- Large 1,692 cu. in. storage capacity.
- Warranty: 1 year parts and labor.

Model	Inside Dimension H x W x D	Outside Dimension H x W x D	Clear Door	Cu. In. Capacity	Wt
ESF1214	11-1/4 x 14-1/2 x 10-3/8	11-1/2 x 14-3/4 x 12-3/4	7-5/8 x 10-11/16	1,672	54

**U.L. LISTED 2-HOUR FIRE AND IMPACT SAFES**



UL1812ST



**OPTIONAL LED LIGHT KIT WITH MOTION SENSOR AVAILABLE FOR ALL MODELS. SEE PAGE 12 FOR DETAILS.**

**U.L. Safes Lifetime Replacement Warranty:**

All AMSEC U.L. Listed fire safes are protected by a LIFETIME FREE REPLACEMENT GUARANTEE, assuring the original owner free replacement of safes that are damaged beyond repair by a fire with a current production model of comparable value. The damaged safe must be returned freight prepaid to the factory within 30 days of the loss, accompanied by a properly filed fire department report.

**FEATURES:**

- The best warranty in the business. Lifetime fire replacement and one year parts and labor.
- U.L. listed Class 350°F two hour fire and impact rating.
- Safes withstand fires of up to 1850°F for two hours and a 30' drop – equivalent to falling through a 2 story burning building.
- Increased barriers for burglary protection. Impressive 3½" thick recessed door with 5/8" thick front for excellent pry resistance.
- Handle activated locking mechanism with 7/8" diameter solid steel chrome plated locking bolts offering smooth operation.
- Internal anchor bolt hole with hardware.
- U.L. listed Group II key changeable combination lock with relock. 1 million possible combinations.
- Auxiliary spring-loaded relock device activated by severe attack.
- Heavy duty steel hinges provide additional security and smooth operation.
- For your convenience, rubber feet are standard on models UL1511 – 1812X.
- Heavy duty rolling casters on UL2018 and up.
- Attractively accented with a brass or chrome handle, decorative emblems and plush velour interior.
- Available in durable Sandstone or Granite textured finishes.

Model	Inside Dim H x W x D	Outside Dim* H x W x D	Cu. In. Capacity	Wt	Shelves
UL1511	15-1/4 x 11 x 12	21 x 17 x 18-1/2	2,139	246	1 Adj. Shelf 1 Base
UL1812	18-1/2 x 12-1/2 x 12	25 x 18 x 18-1/2	2,775	272	1 Adj. Shelf 1 Base
UL1812X	18-1/2 x 12-1/2 x 17	25 x 18 x 23-1/2	3,931	298	1 Adj. Shelf 1 Base
UL2018	20 x 18 x 18	30-1/4 x 25-1/2 x 25-1/2	6,480	542	2 Adj. Shelf 1 Base
UL3918	39 x 18 x 18	49-1/4 x 25-1/2 x 25-1/2	12,636	808	2 Adj. Shelf 1 Base

\* ADD 2" FOR HANDLE, DIAL AND HINGE PROJECTION. OUTSIDE HEIGHT INCLUDES 1" HIGH RUBBER FEET ON MODELS UL1511-UL1812XD; 2¾" FOR CASTERS ON THE THREE LARGEST MODELS.  
Hardware on above safes specify (\*): Brass (LTG) on Sandstone and Chrome (LTE) on Granite  
Color Options Specify (\*\*): (GR) = Granite, (ST) = Sandstone

**U.L. FIRE RESISTIVE RATING CLASSIFICATION**

THE FOLLOWING IS AN EXPLANATION OF THE UNDERWRITER'S LABORATORIES' FIRE RESISTANT CONTAINER TESTING PROCEDURES ON THE CLASS 350°F, ONE HOUR AND TWO HOUR FIRE LABELS.

U.L. Label/Class 350°F-one hour and Class 350°F-two hour. The safe will maintain an interior temperature less than 350°F when exposed to fire for a period of one hour at 1700°F or for a period of two hours at 1850°F. Safe must successfully undergo all other requirements for the Fire Endurance Test, Explosion Hazard Test and the Fire/Impact Test as stated below.

**FIRE ENDURANCE TEST**

After heat sensors and paper are placed inside the safe, the unit is locked and exposed to a uniformly distributed fire. The furnace is regulated to reach a maximum temperature of 1700°F for a period of one hour, or 1850°F for two hours, then allowed to cool without opening the furnace. The interior temperature is recorded throughout the test and during the cooling period until a definite drop is shown and must never exceed 350°F.

Once cooled, the unit is opened and examined for usability. The units locking mechanisms and parts fastenings are examined for security and the interior examined for visible evidence of undue heat transmission.



**EXPLOSION HAZARD TEST**

The safe is locked and placed into a furnace preheated to 2000°F. This temperature is maintained for 30 minutes (2 hour test is 45 minutes) and if no explosion results, the unit is allowed to cool without opening the furnace doors. Once cooled, the unit is opened and examined for usability. The units locking mechanisms and parts fastenings are examined for security and the interior examined for visible evidence of undue heat transmission.

**FIRE IMPACT TEST (MANUFACTURER'S OPTION)**

After the explosion hazard test the safe is removed from the furnace and within two minutes is dropped 30' onto a riprap of brick on a heavy concrete base. After impact the unit is examined for deformation, rupture of parts, damaged insulation and any other openings into the interior of the unit. Once cooled, the unit is inverted and reheated to 1550°F for a period of 30 min. (2 hour test: 45 min. at 1638°F).

Once cooled, the unit is opened and examined for usability. The units locking mechanisms and parts fastenings are examined for security and the interior examined for visible evidence of undue heat transmission.

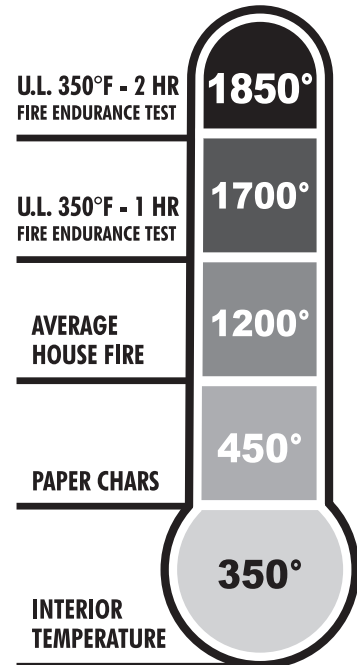





**IMPORTED U.L. LISTED SAFES**

**IMPORTED U.L. LISTED 1-HR FIRE SAFES**

The economical range of our **IMPORTED RESIDENTIAL FIRE SAFES** are the answer's to today's high incidence of residential fires. Our Fire Safes also provide burglary protection making them ideal for home and light commercial applications.



**FS712E5LP**



**FS914**



**FS149E5LP**



**FS149**



**FS1814E5**

**MODELS FS712E5LP, FS914E5LP & FS149E5LP**

- U.L. Listed 350°F 1-Hour fire rating.
- U.L. Listed ESL5LP E-lock. Features include:
  - Illuminated Keypad
  - Factory Reset Combination for resolving lost combinations
  - Beep and flash from every keystroke
  - Lock can be programmed to silence the beep in stealth mode.
  - 15-Minute Penalty Lockout after four incorrect entries
- One (1) drawer shelf (FS712E5LP has a removable shelf).
- Handle operated side-locking mechanism with two chromed locking bolts.
- Two deadbolts prevent door removal
- Four (4) rubber feet.
- Models FS914E5LP and FS149E5LP have One (1) internal anchor hole and hardware.
- Attractive two-toned sage finish.

**IMPORTED RESIDENTIAL FIRE SAFES (COMBO)**

**FEATURES: FS914 / FS149:**

- U.L. Listed 350°F 1-Hour fire rating.
- Models FS914 and FS149 have one (4) rubber feet and one (1) drawer shelf
- Key operated side-locking mechanism with two chromed locking bolts.
- Two deadbolts prevent door removal
- (1) internal anchor hole and hardware,
- Attractive two-toned sage finish.

**AMSEC's FS Series is the only 1hr. economical fire safe with a high-security electronic lock.**

**Other Brands AMSEC**



**MODEL FS1814E5**

- U.L. Listed 350°F 1-Hour fire rating.
- U.L. Listed ESL5 E-lock. Features include:
  - Illuminated Keypad
  - Factory Reset Combination for resolving lost combinations
  - Beep and flash from every keystroke
  - Lock can be programmed to silence the beep in stealth mode.
  - 15-Minute Penalty Lockout after four incorrect entries
- Handle operated side-locking mechanism with two chromed locking bolts.
- Two deadbolts prevent door removal.
- One (1) key-lock drawer and one adjustable shelf.
- Four (4) removable rolling casters.
- One (1) internal anchor hole and hardware,
- Attractive two-toned sage finish.

**OPTIONAL LED LIGHT KIT WITH MOTION SENSOR AVAILABLE FOR ALL MODELS. SEE PAGE 12 FOR DETAILS.**



**Residential Fire Safes (Electronic and Combo)**

Model	Inside Dim H x W x D	Outside Dim* H x W x D	Clear Door	Cu. In.	Wt
FS712E5LP	7 x 11-7/8 x 8-1/2	11-13/16 x 16-1/2 x 13-3/4	7 x 11-7/8	660	70
FS914E5LP	8-13/16 x 14-3/8 x 9-7/8	14 x 19-1/2 x 15-3/8	8-13/16 x 14-3/8	1,107	96
FS149E5LP	14-3/8 x 8-13/16 x 9-7/8	19-1/2 x 14 x 15-3/8	14-3/8 x 8-13/16	1,258	96
FS914	8-13/16 x 14-3/8 x 9-7/8	14 x 19-1/2 x 15-3/8	8-13/16 x 14-3/8	1,189	96
FS149	14-3/8 x 8-13/16 x 9-7/8	19-1/2 x 14 x 15-3/8	14-3/8 x 8-13/16	1,258	96
FS1814E5	13-5/8 x 13-1/8 x 12-3/8	23-5/8 x 18-7/8 x 18-7/8	13-5/8 x 13-1/8	2,920	187

\*Add 2" for handle, dial and hinge projection.

Model FS1814E5 has one key-lock drawer and one adjustable shelf.

Dimensions have been converted from metric measurements. Please allow +1/4" to 1/4" variation for both outer and inner dimensions listed.



**WALL SAFES**

AMSEC **WALL SAFES** are designed to provide hidden protection for documents and miscellaneous valuables. Each wall safe is also designed for easy installation between 16" o/c wall studs. Pre-drilled anchor holes and a built-in flange eliminates unnecessary replastering.



**WEST2114 FEATURES:**

- Heavy duty steel body, 3/16" solid steel door and flange.
- Extra spacious interior, while still offering the convenience of fitting between studs.

- State-of-the-art

DL5000 electronic lock with a large 3 3/4" touch screen LCD input display allows smooth and easy operation.

- Mode altering display changes from orange in standby mode to bright blue in the open position.
- Accepts (2) user codes and can show open door records for the past 14 entries.
- LCD touch screen display shows low-battery indicator, time, date and keypad.
- Emergency key-lock override system with two (2) keys, power override battery box, built-in spy-proof function and motion detector alert.
- Dual live bolts ensure protection against pry attacks.
- Two removable shelves.
- Cream colored, durable powder coated finish.
- Packaged for UPS shipment.



WS1014

**WS1014**

**FEATURES:**

- U.L. listed Group II key changeable lock, with relock and 1 million possible combinations.
- Electronic lock optional.
- Flat dial allows flush mounted installation.
- 3/16" thick solid steel door with dead bar.



WFS149E5LP

**When fire is a concern, there is no better wall safe than the WFS149 or WFS149E5LP.**

**WFS149**

**FEATURES:**

- UL Listed one hour fire rating, ensuring the inside temperature never exceeded 350° F (paper chars at 450° F).
- Extra deep interior, with one (1) convenient drawer shelf.
- Combo lock with key operated side-locking mechanism incorporating one chromed locking bolt.
- Each safe is equipped with side locking boltwork mechanism incorporating 1/2" steel deadbolts.
- Impressive 1/2" thick door with attractive two-tone Sage finish.



WS1214E5

**HEAVY-DUTY WS1214E5**

**FEATURES:**

- Same features as Super Brute Floor safes. Please see page 19.
- Two removable shelves. Extra deep interior.
- AMSEC's ESL5 electronic lock with illuminated keypad.

**WFS149E5LP with ESL5LP Electronic Lock:**

- Illuminated Keypad
- Factory Reset Combination for resolving lost combinations without requiring expensive service calls.
- Beep and flash from every keystroke gives maximum feedback to the user.
- Lock can be programmed to silence the beep in stealth mode.
- 15-Minute Penalty Lockout after four incorrect entries protects against manipulation attempts.
- One 9-volt battery can be easily replaced in the keypad housing.

Model	Inside Dimension H x W x D	Outside Dimension H x W x D	Clear Door H x W	Cu. In.	Wt.
WS1014	10 x 13-3/4 x 3-1/2	10-1/4 x 14 x 4	9-5/8 x 12-3/4	481	20
WFS149*	14 x 8-1/2 x 10-1/2	19-1/8 x 13-1/2 x 15-3/4	14 x 8-1/2	1258	106
WFS149E5LP*	14 x 8-1/2 x 10-1/2	19-1/8 x 13-1/2 x 15-3/4	14 x 8-1/2	1258	106
WS1214E5	12-1/4 x 13-5/8 x 5-1/4	12-5/8 x 14 x 10	10-3/4 x 11-1/4	891	86
WEST2114	20-7/8 x 13-3/4 x 2-7/8	21 x 13-7/8 x 4	19-1/4 x 10-1/4	733	31

\* 350° F, UL Listed, 1-Hr fire rated wall safe.



**BRUTE AND SUPER BRUTE**

**SQUARE DOOR FLOOR SAFES**

All BRUTE SERIES safes are designed to provide secure storage for documents, jewelry, precious metals and miscellaneous valuables at an economical price. When properly installed in a concrete floor, BRUTE SERIES safes provide excellent fire and burglary protection. BRUTE floor safes meet and exceed the requirements of the Insurance Offices Manual of Burglary Insurance. You may also add many options to customize your safe such as: A drop slot in the door, depository chute, digital keypad lock and keylocking dial to name a few. BRUTE SERIES safes may be installed in the floor, wall, cladding or within a larger safe.

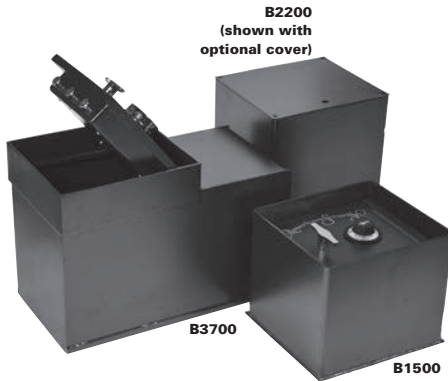

- One piece heavy duty dead bar behind hinge prevents removal of door even if hinges are removed during a forced entry attempt.
- Doors are interchangeable within product group.

**BODY:**

- Oversize floor plate ensures strong installation in concrete.
- Flush cover plate.
- Solid steel hinge mechanism using 3/8" diameter steel hinge pins and internal mounting bolts.

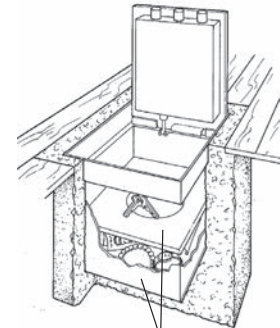

**DOUBLE COMPARTMENT**

**SUPER BRUTE & BRUTE**

**STANDARD FEATURES:**

- Black textured body and door.
- Attractive design offers strong reliable welds to protect against burglary attacks and reduce possible leakage.
- U.L. listed Group II combination lock.
- An additional spring-loaded relocking device, activated by a punching attack.
- Lock and relocks are protected by a large carburized hardplate.
- A handle activated locking mechanism consisting of three 1" diameter locking bolts. Each one is drive resistant, chromed steel with a long throw.

**SUPER BRUTE SERIES**

**ADDITIONAL FEATURES:**

- The **SUPER BRUTE's** new door jamb design is manufactured with state-of-the-art equipment, with built-in devices offering the ultimate protection against sledgehammer attack.
- **3/4" solid steel plate door** is standard.
- Doors are removable and interchangeable.
- A large, convenient 10 3/4" x 11 1/8" door opening for bulky items.
- One sliding shelf with double wide model (B3700).
- Attractive carpeted floor in every unit.

**BRUTE RECTANGULAR BODY, WIDE DOOR**

**ADDITIONAL FEATURES:**

- A large, convenient 11 3/4" x 16" door opening, for large bulky items or cash tray storage.
- 1/2" solid steel plate door.

**Super Brute Floor Safes  
Lifetime Replacement Warranty**

For more information visit our website at:  
<http://www.amsecusa.com/floor-safes/brute/>

**SuperBrute "B" Rate Rectangular Hinged Door Floor Safes**

Model	Inside Dimension H x W x D	Outside Dimension H x W x D	Clear Door H x W	Cu. In. Capacity	Wt.
B1500*	12-1/4 x 13-1/4 x 8-3/4	12-3/4 x 14-1/8 x 11-3/4	10-3/4 x 11-1/8	1377	102
B2200*	12-1/4 x 13-1/4 x 14	12-3/4 x 14-1/8 x 17 1/2	10-3/4 x 11-1/8	2203	118
B2900*	12-1/4 x 13-1/4 x 18-1/4	12-3/4 x 14-1/8 x 21-3/8	10-3/4 x 11-1/8	2872	134
B3800*	12-1/4 x 18 x 17	12-3/4 x 18-3/4 x 21-3/8	10-3/4 x 11-1/8	3864	136
B3700*	12-1/4 x 23 x 14	12-3/4 x 24 x 17 1/2	10-3/4 x 11-1/8	3785	145
B5800*	12-1/4 x 35 x 14	12-3/4 x 36 x 16-3/4	10-3/4 x 11-1/8	5758	185

\*Constructed of 3/4" door and B-Rate body. For Slotted door, see page 38. Slotted outer door not recommended for use on B1500.

**Brute Wide Door "B" Rate Rectangular Hinged Door Floor Safes**

Model	Inside Dimension H x W x D	Outside Dimension H x W x D	Clear Door H x W	Cu. In. Capacity	Wt.
B1806	12-1/4 x 18 1/2 x 6	13-1/4 x 19 1/2 x 9	11-3/4 x 16	1360	102
B1810	12 1/8 x 18 1/2 x 10	13-1/4 x 19 1/2 x 13	11-3/4 x 16	2281	116
B1816	12-1/4 x 18 1/2 x 16	13-1/4 x 19 1/2 x 19	11-3/4 x 16	3626 (top)	142
B1816D*	12-1/4 x 18 1/2 x 5-3/4 (top) 12-1/4 x 18 1/2 x 10 (btm)	13-1/4 x 19 1/2 x 19	11-3/4 x 16 (top) 6-3/8 DIA (btm)	1303 (btm) 2266	152

\*Double Compartment - Slotted inner door. Slotted door not recommended for use on B1806.

# STAR® ROUND LIFT-OUT DOOR



FLOOR SAFES are engineered with advanced security features. STAR Tube safes have been the standard for gas stations, fast food, small retail establishments and home owners for over 50 years.

Low cost, combined with the various body styles and optional doors will fit almost any cash handling system. When properly installed in concrete, STAR® FLOOR SAFES provide maximum fire and burglary protection. Now, with the water-resistant dust cover, you get protection from water as well.

## “C” RATE LIFT-OUT DOOR FEATURES:

- Manipulation resistant, unitized key changeable lock protected by a revolving carburized hardplate.
- Removable dial and drive/drill resistant spindle preventing damage from burglary attack and additional protection from hold-up.
- Door, 7-1/4" clear opening, is 1-3/4" solid steel.
- Door is securely locked by three bolts each requiring over 25,000 pounds to shear.
- Each locking bolt has its own hardened steel positive relocking bolt.
- Body — Heavy “B” rate construction.

## OTHER FEATURES:

- Water resistant, high impact molded dust cover with rubber “O”-ring seal does not rattle or slide like most covers.
- STAR’s double compartment models provide the commercial user with the most effective cash handling system available. Hold-up as well as burglary protection is greatly enhanced by use of this type of safe.
- Available with dual key inner compartment. Manager holds one key, the armored car driver, or employee holds the second.



STAR® “C” RATE TUBULAR BODY SAFES



CUTAWAY VIEW OF STAR® DOUBLE COMPARTMENT

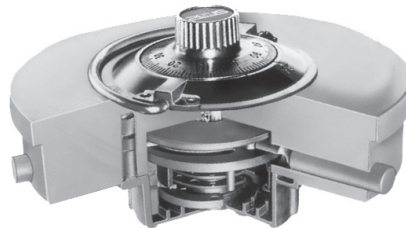

CUTAWAY VIEW “C” RATE LIFT-OUT DOOR



COMBINATION DOOR WITH DROP SLOT



WATER RESISTANT DUST COVER



KEYLOCK DOOR

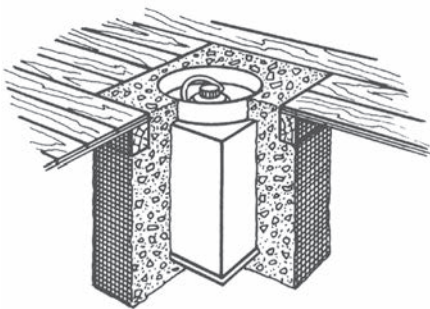

When properly installed in concrete, STAR® Floor Safes provide excellent fire and burglary protection. Now, with the water resistant dust cover, you get protection from water as well.

Model	Inside Dimension H x W x D	Outside Dimension H x W x D	Clear Door H x W	Cu. In. Capacity	Wt.
C3 / K3 †	8-1/4 DIA x 5-3/4	8-3/4 DIA x 9	7-1/4 DIA	280	40
C5 / K5 †	8-1/4 DIA x 10	8-3/4 DIA x 13½	7-1/4 DIA	510	48
C7 / K7 †	8-1/4 DIA x 16	8-3/4 DIA x 19	7-1/4 DIA	785	55
CD5* / KD5 †	8-1/4 DIA x 4-1/4 (top) 8-1/4 DIA x 4½ (btm)	8-3/4 DIA x 13½	7-1/4 DIA (top) 6-3/8 DIA (btm)	225 (top) 240 (btm)	54
CD7* / KD7 †	8-1/4 DIA x 5-1/4 (top) 8-1/4 DIA x 9 (btm)	8-3/4 DIA x 19	7-1/4 DIA (top) 6-3/8 DIA (btm)	175 (top) 480 (btm)	66

\*Double Compartment - Slotted Inner Door † (K) = Key lock door



**STAR® RECTANGULAR BODY, ROUND LIFT-OUT DOOR**

FLOOR SAFES



Rectangular Body, Round Lift-out Door  
**"B" RATE**

**FLOOR SAFES** offer a large cubic inch capacity at a reasonable price. Strong, continuously welded steel bodies are offered with our standard "C" rate lift-out combination door and water-resistant dust cover.



**"C" RATE LIFT-OUT FEATURES**

**DOOR:**

- Utilizes the STAR high security "C" Rate door.

**BODY:**

- "B" Rate construction available in double compartment models (D) or outside drop chute (BDP).

Model	Inside Dimension H x W x D	Outside Dimension H x W x D	Clear Door H x W	Cu. In. Capacity	Wt.
B6	12 x 10 x 5-1/4	12½ x 11-1/4 x 9-3/4	7-1/4 DIA	630	62
B17	12 x 12½ x 10	13 x 13 x 15	7-1/4 DIA	1500	98
B24	12 x 12½ x 14½	13 x 13 x 19	7-1/4 DIA	2175	122
BD24*	12 x 12½ x 5½ (top) 12 x 12½ x 10 (btm)	13 x 13 x 20	7-1/4 DIA (top) 6-3/8 DIA (btm)	825 (top) 1500 (btm)	130
BDP24*	12 x 12½ x 4-1/4 (top) 12 x 12½ x 13-3/4 (btm)	13 x 13 x 22	7-1/4 DIA (top) 6-3/8 DIA (btm)	638 (top) 2063 (btm)	142

\*Double Compartment-Slotted Inner Door. \*\*Double Compartment - Solid Inner Door with Outside Drop Chute



**MAJOR® ROUND LIFT-OUT DOOR**

**MAJOR®** Tubular Body, Round Lift-Out **DOOR FLOOR SAFES** provide excellent fire and burglary protection when properly installed in concrete.

**"C" RATE LIFT-OUT DOOR FEATURES**

- Unitized key changeable lock with randomized opening positions defends against drill attacks.
- Drive resistant dial and spindle blocks sledgehammer attacks.
- Door, 6<sup>5</sup>/<sub>8</sub>" clear opening, is 1" thick solid steel.
- Door is securely closed by three 5<sup>5</sup>/<sub>8</sub>" drive resistant locking bolts.
- A positive relocking device jams locking mechanism in the event of a forced entry attempt.
- Recessed locking mechanism protected by a large carburized hardplate.
- Heavy duty "B" rate solid steel body with reinforced door jamb.
- Available in double compartment models (DD) with a key locking inner door.
- Inside slot to bottom compartment on all (DD) models.



Model	Inside Dimension H x W x D	Outside Dimension H x W x D	Clear Door H x W	Cu. In. Capacity	Wt.
T425	8-1/4 DIA x 5-3/4	8-5/8 DIA x 8-3/4	6-5/8 DIA	307	40
T625	8-1/4 DIA x 10-1/4	8-5/8 DIA x 13-1/4	6-5/8 DIA	545	46
T925	8-1/4 DIA x 15-3/4	8-5/8 DIA x 18-3/4	6-5/8 DIA	840	54
T625DD*	8-1/4 DIA x 4½ (top) 8-1/4 DIA x 5-1/4 (btm)	8-5/8 DIA x 13-3/4	6-5/8 DIA (top) 6-3/8 DIA (btm)	241 (top) 285 (btm)	54
T925DD*	8-1/4 DIA x 7½ (top) 8-1/4 DIA x 7-3/4 (btm)	8-5/8 DIA x 18-3/4	6-5/8 DIA (top) 6-3/8 DIA (btm)	401 (top) 420 (btm)	64

\*Double Compartment - Solid Inner Door with Drop Chute.



CUTAWAY VIEW OF "MAJOR" DOOR

**CASHWIZARD® BILL READER SAFES**



**THE CASHWIZARD® BILL READER SAFES** Offers a wide range of capabilities from MEI bill validators increasing cash processing speeds, a thorough reporting system to make accurate and verified reports, a comprehensive access control system and remote capabilities.



BR3120



BR3119



BR3113



BR2013 (W/OPT. BASE)



BR2012

**Features:**

**Cash Management**

- Streamlines the cash management process, increases accuracy and reduces theft or cashier error.
- Provides full visibility to cash deposits from multiple locations.
- Monitors daily cash volumes.
- Deposit tracking system to provide the highest level of cash management security
- MEI Cashflow bill readers that count and verify cash deposits
- Manual Drop tracking for mutilated cash, coins, checks and other items
- Reports available by transaction, user, shift and business day
- Armored carrier compatible

**Asset Protection**

- Superior AMSEC Hardware: Anti-Spread Dead latch Locks, Heavy Duty Bolts, Anti-Pry Door Jams, Steel that is one-half-inch thick.
- Encrypted Data Communication and Time Locks/Delays for ultimate software security.

**Remote Management**

- Available via exclusive CashWizard Admin and Ethernet, Cellular or Wi-Fi connection.
- Data transfers from the safe to the cloud, exportable to multiple file formats and devices.
- Add/Edit/Delete Users
- Run Reports – Cash Management and Audit reports

- Manage System Settings (Safe Time, Door Delay, End of Day, etc.)
- Create Event based Alerts for each safe (Cassette Full, Courier Event, Door Opened, etc.)

**Access Control**

- 120,000 audit entries and up to 500 users
- Time Delay any door
- Time Lock any door, 1-6 windows per day
- Authentication options: PIN code and/or Dallas Key
- Wrong PIN penalty lockout
- Duress Hold-Up Alarm with Silent Signal
- Burglary Alarm output signal
- Holiday schedule with up to 16 programmable events per year
- Automatic Daylight Savings Adjustment, selectable and configurable
- Dual control mode on any door
- Audit record written for each transaction

Model	Description	Outside Dimension H x W x D	Wt.
<b>CashWizard II Safes with Built-in Printer - All-In-One</b>			
BR3119	"All-In-One" 3 Door Smart Safe (Dual 1200 Note Bill Readers)	30-1/8 x 19 x 20-1/2	350
<b>CashWizard II Safes - 2 bill reader - "SS"</b>			
BR3120 -1-2-3-4	3 Door Smart Safe	30-1/2 x 20 x 18	399
BR3113 -1-2-3-4	2 Door Smart Safe	30-3/4 x 13 x 22-3/8	265
BR2013 -1-2-3-4	1 Door Smart Safe	19-3/4 x 13 x 22-3/8	206
<b>CashWizard II Safes - 1 bill reader - "S"</b>			
BR2012-S-SD-1-2	1 Door Smart Safe / 1- Single Note Reader, 1200 Note Cassette	19-3/4 x 11-5/8 x 22-3/8	186

\* Using the Configuration options to the right, see below for an example of how to build the part number:

EXAMPLE: BR3113-SS-SD-NL-AP

BR3113 - 2 single note readers - 1200 note cassettes - No lock on bill readers - Attached printer

**"SS" Configuration Options:**

- 1 = add "SS" to the part number for 2 single note reader
  - add "BB" to the part number for 2 bunch note feeders
  - 2 = add "SD" to the part number for 1200 note cassettes
  - "XL" to the part number for 2200 note cassette†
  - 3 = add "NL" to the part number for no lock on bill readers
  - add "BL" for lock on bill readers
  - 4 = add "AP" for Attached Printer
  - add "DP" for Detached Printer
- †"XL" adds 6" to depth and 30 lbs. to BR2013 or 50 lbs. to BR3113

**"S" Configuration Options:**

- 1 = add "NL" to the part number for no lock on bill reader
- add "BL" for lock on bill reader
- 2 = add "AP" for Attached Printer
- add "DP" for Detached Printer



**CASHWIZARD® BILL READER SAFES**

CASH MANAGEMENT SAFES

**CASH WIZARD SAFE FEATURES**



	<b>BR3120</b>	<b>BR3119</b>	<b>BR3113</b>	<b>BR2013</b>	<b>BR2012</b>
Number of Doors	3	3	2	1	1
Outside Dim	30-1/8"H x 19"W x 20-1/2"D	30-1/2"H x 20"W x 18"D	30-3/4"H x 13"W x 22-3/8"D	19-3/4"H x 13"W x 22-3/8"D	19-3/4"H x 11-5/8"W x 22-3/8"D
Body steel thickness	1/4"	1/4"	1/4"	1/4"	1/4"
Weight Lbs.	399	350	265	206	186
MEI Cashflow SCL-1200 note validators	2 (Behind door 1)	2 (Behind door 3)	2 (Behind door 1)	2 (Behind door 1)	1 (Behind door 1)
Optional bunch note bill readers	Yes	No	Yes	Yes	No
Optional 2200 note cassettes	Yes	Yes	Yes	Yes	No
Extra cassette storage area	Yes	Yes	Yes	Yes	Yes
Opt. restricted access bill reader door	Yes	No	Yes	Yes	Yes
Integrated thermal direct printer	Yes	Yes	Yes	Yes	Yes
Opt. detached printer	Yes	Yes	Yes	Yes	Yes
Cash till storage	Yes (Behind door 2)	Yes (Behind door 1)	No	No	No
Opt. base	No	No	No	Yes	Yes
Anchor holes	Yes	Yes	Yes	Yes	Yes
Door 1	Outer Door (Bill Readers)	Outer Door (Main access)	Outer Door (Bill Readers)	Outer Door (Bill Readers)	Outer Door (Bill Readers)
Steel thickness	1/2"	3/8"	1/2"	1/2"	1/2"
Anti spread dead latch locking	Yes	Yes	Yes	Yes	Yes
Dead bars	Yes	Yes	Yes	Yes	Yes
Auto locking door	Yes	Yes	Yes	Yes	Yes
Manual deposit slot	Yes	No	Yes	Yes	Yes
Coin racks	Yes	Yes	No	No	No
Bulk coin storage pocket	No	Yes	No	No	No
Door 2	Outer Door (Deposits,change fund, tips)	Inner locker (Deposits,change fund, tips)	Outer Door (Managers locker)		
Steel thickness	1/2"	1/4"	1/2"		
Anti spread dead latch locking	Yes	No	Yes		
Dead bars	Yes	No	Yes		
Auto locking door	Yes	Yes	Yes		
Large anti-fish depository	Yes	Yes	No		
Opt. manual deposit slot	n/a	n/a	Yes		
Door 3	Outer Door (Cash till storage)	Inner locker (Bill readers)			
Steel thickness	1/2"	1/4"			
Anti spread dead latch locking	Yes	No			
Dead bars	Yes	No			
Auto locking door	Yes	Yes			

**RETAIL MONEY MANAGER SAFE**



**AMSEC's NEW RETAIL MONEYMANAGER SAFE** offers unrivaled value in electronic safe access. Built tough to maximize protection against burglary attempts, the Retail MoneyManager has all the advanced features necessary for commercial applications.

**Safe Features:**

- Solid steel 1/2" thick door equipped with 10 solid steel Anti-Spread Pins
- Formed high tensile steel body and jamb construction to maximize protection against pry attack.
- Provided with 6 removable door mounted coin racks
- Reinforced internal jambs on all four sides provide protection against sledgehammer attack.
- 3-way locking system with five 1" dia. Chrome plated locking bolts.
- Bolt detent system engages boltwork and locks the door automatically.
- Auxiliary spring-loaded reloading devices.
- Locks and relocks protected by a large carburized hardplate.
- Standard Four (4) anchor bolt holes.

**Interior Locker Features:**

- Heavy 1/4" steel door, 9-1/4" H x 19-3/4" W x 13-1/2" (12-7/8" Clear) D
- Large clear door opening: 6-9/16" H x 14" W
- Locker door closes when outer door is closed.

**Deposit Drawer Features:**

- Large "fish" and "pry" resistant solid steel deposit drawer deposits.
- Drawer size: 2" x 4-1/4" x 9-1/2"

**Lock Features:**

- The Retail MoneyManager Safe is available with either the AMSEC SafeWizard® Electronic lock, AMSEC ESLAudit Electronic Lock or the AMSEC ESL20-XL Electronic Lock.



**RMM2620SW-R**



**RMM2620SWII-R**

More information on the SafeWizard® Lock can be found on Page 39



**RMM2620ESLAUDIT-R**

More information on the ESLAudit Lock can be found on Page 40



**RMM2620ESL20-R**

More information on the ESL20XL Lock can be found on Page 41

Model	Description	Inside Dimension H x W x D	Outside Dimension H x W x D	Clear Door H x W	Wt.
RMM2620SW-R	C-Store Cash Management Safe / Right Swing / with SafeWizard II	25-3/4" x 19-3/4" x 15-5/8"	26" x 20" x 18 1/2"	18-1/4" x 15 1/2"	280
RMM2620ESLAudit-R	C-Store Cash Management Safe / Right Swing / with ESLAudit	25-3/4" x 19-3/4" x 15-5/8"	26" x 20" x 18 1/2"	18-1/4" x 15 1/2"	280
RMM2620ESL20-R	C-Store Cash Management Safe / Right Swing / with ESL20XL (Time Delay)	25-3/4" x 19-3/4" x 15-5/8"	26" x 20" x 18 1/2"	18-1/4" x 15 1/2"	280



**RMM3124ESLAudit Features:**

- Extra large storage compartment for cash tills, cash box, cash bag and bulk coin.
- Comes standard with 9 door mounted coin racks.
- Extra large deposit compartment with anti-fish rotary hopper.
- LED light with motion sensor make it easy to see inside both the rotary hopper and deposit compartment.
- 1/2" thick solid steel doors
- Formed high tensile steel body
- Both doors auto lock when closed
- Built-in alarm contacts on both doors

- Four anchor bolt holes
- ESLAudit lock offers:
  - Controls both doors
  - Easy to read back-lit display
  - Audits all safe functions
  - Time Delay and Time lock on both doors
  - Courier bypass
  - A/C power with battery back-up
  - Auto daylight savings adjustment
  - English and Spanish options
  - And Much More!

Model	Description	Inside Dimension H x W x D	Outside Dimension H x W x D	Clear Door H x W	Wt.
RMM3124ESLAudit	2D Depository Safe w/ESLAudit with AC Power Supply	Left - 30-3/4" x 15-3/8" x 17-3/8" Right - 24-1/2" x 8-3/4" x 17-3/8"	31" x 24 1/2 x 20	Left-28" x 13-1/2" Right-12-5/8" x 5-3/4"	360





**MONEY MANAGER SERIES**

**DEPOSITORY SAFES**

AMSEC's "B" Rate Money Manager Series Undercounter Two Door Depository Safes are the most effective cash handling systems available. Engineered to help you achieve total cash control.

**STANDARD FEATURES:**

- 1/2" solid steel doors.
- ESL15 electronic lock.
- Optional auxiliary key locks with dual control.
- Three 1" diameter locking bolts.
- Auto lock bolt detent.
- Auxiliary relock device.
- Large carburized hardplate.
- Coin racks.
- Front hopper: 16 1/4"W x 2"H x 3 1/2"D.
- Front hopper features "anti-fish" baffles.
- Four anchor bolts with hardware.
- 3 models: top, center or three drop.
- Top drop offers three color-coded drops and bins.
- Attractive Charcoal Gray textured finish.



**MM2820E15 TOP DROP W/OPTIONAL KEY LOCK**



**MM2820E15 CENTER DROP**



**MM2820E15 THREE DROP**

Model	Inside Dimension H x W x D	Outside Dimension H x W x D	Clear Door H x W	Cu. In. Capacity	Wt.
MM28203-Drop-E15	TOP 9 1/2 x 20 x 17 BTM 11 x 20 x 17	28 x 20 1/2 x 20	8 1/2 x 16-1/4 8 1/2 x 16-1/4	3,230 3,740	247
MM2820Top-Drop-E15	TOP 9 1/2 x 20 x 17 BTM 11 x 20 x 17	28 x 20 1/2 x 20	8 1/2 x 16-1/4 8 1/2 x 16-1/4	3,230 3,740	274
MM2820Ctr-Drop-E15	TOP 10-3/8 x 20 x 17 BTM 10-3/8 x 20 x 17	28 x 20 1/2 x 20	8 1/2 x 16-1/4 8 1/2 x 16-1/4	3,230 3,740	278

**DS SERIES TILL STORAGE DEPOSITORY SAFES**



**DSF2516E2**

**DSR2516E2  
SHOWN FROM THE  
BACK WITH REVERSE  
HOPPER VISIBLE**

**BODY**

- 1/8" solid steel plate
- Four anchor bolt holes

**DOOR**

- 1/2" solid steel plate
- ESL20XL, U.L. Type 1 High Security electronic lock
  1. Time Delay
  2. Multiple users
  3. Dual Control
- 4. Armored car override.
- Three 1" dia. steel locking bolts.
- Auto lock bolt detent system
- Auxiliary relocking device.
- Large carburized hardplate

**INTERIOR**

- Receiving locker:
  1. 1/4" solid steel plate
  2. Clear door: 6"H x 10"W
  3. ID: 5 7/8"H x 15 3/4"W x 13 3/4"D
  4. Cubic capacity: 1272 cu/in.

- Till Storage Compartment
  1. Fit up to 4 till trays
  2. Clear door: 14 1/2" h x 12" w
  3. Inside Dimensions: 9"h x 15 3/4"w x 17"d
  4. Cubic capacity: 2410 cu/in.

**FRONT HOPPER**

- Large package sizes: 4"D x 2 3/4"W x 10 1/2"L
- 1/4" solid steel plate
- Dual "anti-fish" baffles.

**REVERSE HOPPER**

- Large package sizes: 4"D x 2 1/2"W x 9 1/2"L
- 1/8" solid steel plate
- Protected by dual "anti-fish" baffles
- Thru the wall depository with adjustable chute
- Wall Thickness: 6 7/8" to 13 7/8"
- Floor Height: 36 3/4" to 48 3/4"

Model	Inside Dimension H x W x D	Outside Dimension H x W x D	Clear Door H x W	Cubic Inches	Wt.
DSF2516E2	24-3/4 x 15-3/4 x 17	25 x 16 x 20	14-1/2 x 12	3,682	240
DSR2516E2	24-3/4 x 15-3/4 x 17	25 x 16 x 20	14-1/2 x 12	3,682	260



## BWB SERIES - WIDE BODY CASH CONTROL

Extensive research and development went into the engineering of AMSEC'S **WIDE BODY "B" RATE CASH HANDLING DEPOSITORY SAFES**. Designed to offer complete cash management versatility with a front load depository option or a pull-out deposit drawer (Models BWB3020D1 and BWB3020D1 only).



**BWB2020FL WITH  
OPTIONAL SAFEWIZARDII®**



**BWB3020-D1**



**BWB2020-FL**

### BWB STANDARD FEATURES:

- Door: Massive 1/2" thick A36 solid steel plate.
- Formed high tensile steel body and jamb construction to maximize protection against pry attack.
- Reinforced internal jambs on all four sides to provide protection against sledgehammer attack.
- U.L. listed Group II, key changeable combination lock.
- Optional electronic locks available.
- 3-way locking mechanism consisting of five 1" diameter chromed steel locking bolts.
- Bolt detent system engages boltwork automatically.
- Locks and relocks protected by a large carburized hardplate.

- Auxiliary spring-loaded relocking devices.
- Convenient, door-mounted, recessed coin rack.
- Standard Four (4) anchor bolt holes.

### INTERIOR LOCKER FEATURES:

- Heavy 1/4" steel door, and single-key camlock with two keys.
- Large clear door opening:  
6" H x 12"W (for 20" W safes) or  
6" H x 14"W (for 25" W safes).
- Inside Dimensions:  
BWB2020 / BWB3020 / BWB4020:  
8 5/8" x 19 3/4" x 14"  
BWB2025 / BWB3025 / BWB4025:  
8 5/8" x 24 3/4" x 19"
- Note: Front Load Depository - inside locker height restricted to 6".

### DEPOSIT DRAWER FEATURES (ONLY MODEL BWB3020D1):

- Large "fish" resistant, pull out drop drawer deposits directly into standard interior locker.  
Drawer size: 1 1/8" x 3 1/2" x 7 1/2"
- Heavy duty steel sliding drawer.

### FRONT LOAD DEPOSITORY FEATURES:

- Recessed heavy duty 1/8" construction with 1/8" door.
- Protected by dual "anti-fish baffles."
- Large package capacity: 4" x 9" x 11 1/2" (maximum).
- May be ordered in any one of four directions. Specify front, reversed, right load or left load.

EACH UNIT COMES EQUIPPED WITH AN INTERIOR LOCKER TO ACCOMMODATE DEPOSITS, A LARGE INTERIOR FOR STORAGE OF CASH TRAYS AND BULK COIN.

Model	Inside Dim H x W x D	Outside Dim † H x W x D	Clear Door H x W	Cu. In.	Wt*	Shelves
BWB2020FL	9 x 19-3/4 x 17	29-3/4 x 20 x 20	14-3/4 x 16-1/4	3,022	218	0
BWB2020FLNL	19-3/4 x 19-3/4 x 17	29-3/4 x 20 x 20	14-3/4 x 16-1/4	6,630	260	1
BWB2020FLRNL	19-3/4 x 19-3/4 x 17	29-3/4 x 20 x 20	14-3/4 x 16-1/4	6,630	260	0
BWB2020FLR	9 x 19-3/4 x 17	29-3/4 x 20 x 20	14-3/4 x 16-1/4	3,022	218	0
BWB3020FL	19 x 19-3/4 x 17	39-3/4 x 20 x 20	24-3/4 x 16-1/4	6,380	278	2
BWB3020FLR	19 x 19-3/4 x 17	39-3/4 x 20 x 20	24-3/4 x 16-1/4	6,380	278	2
BWB4020FL	29 x 19-3/4 x 17	49-3/4 x 20 x 20	34-3/4 x 16-1/4	9,737	360	3
BWB4020FLR	29 x 19-3/4 x 17	49-3/4 x 20 x 20	34-3/4 x 16-1/4	9,737	360	3
BWB2025FL	9 x 24-3/4 x 22	29-3/4 x 25 x 25	14-3/4 x 21-1/4	4,900	285	1
BWB2025FLR	9 x 24-3/4 x 22	29-3/4 x 25 x 25	14-3/4 x 21-1/4	4,900	285	1
BWB3025FL	19 x 24-3/4 x 22	39-3/4 x 25 x 25	24-3/4 x 21-1/4	10,345	352	2
BWB3025FLR	19 x 24-3/4 x 22	39-3/4 x 25 x 25	24-3/4 x 21-1/4	10,345	352	2
BWB4025FL	29 x 24-3/4 x 22	49-3/4 x 25 x 25	34-3/4 x 21-1/4	15,790	440	3
BWB4025FLR	29 x 24-3/4 x 22	49-3/4 x 25 x 25	34-3/4 x 21-1/4	15,790	440	3
<b>B-Rate Wide Body Depository Chest with Drawer</b>						
BWB3020-D1	19-3/4 x 19-3/4 x 17	30 x 20 x 20	24-3/4 x 16-1/4	6,380	270	2
BWB2020-D1	19-3/4 x 19-3/4 x 17	20 x 20 x 20	14-3/4 x 16-1/4	3,063	180	2

### IMPORTANT:

AMSEC depository safes are recommended for an operation that requires a non-returnable deposit such as armored car companies, convenience stores, restaurants, etc. The top locker is not meant for overnight storage of cash or valuables.

†Add 2" for handle, dial and hinge projection.



**BWB SERIES AND MS1414**

**"B" RATE SECURITY SAFES**

The many different features of the WIDE BODY SAFES, make them perfect for commercial application or home use.



**BWB3020**



**BWB2020**



**MS1414 WITH  
ESL10XL LOCK**



**MS1414KS WITH  
SLOT OPTION**

**Standard Features for BWB:**

- ½" thick solid steel door, recessed for resistance to pry attacks.
- Formed, high-tensile steel body and jamb construction to maximize protection against pry attacks.
- U.L. listed Group II key changeable combination lock with over 1 million possible combinations.
- Optional electronic locks available.
- Auxiliary spring-loaded relock device.
- Locks and relocks protected by a large carburized hardplate.
- Attractive Charcoal Gray textured finish.
- BWB: Four anchor bolt holes.

**Additional BWB Series Features:**

- Reinforced internal jambs on all four sides to provide excellent protection against sledgehammer attack.
- 3-way locking mechanism consisting of five massive 1" diameter chromed steel locking bolts.
- Bolt detent system keeps bolts retracted when the door is open, then automatically engages when door is shut.
- Convenient door mounted recessed coin rack.
- Large capacity for storage of cash trays.
- Adjustable shelves.

**Mini Safe (MS Series) Features:**

- Formed, high-tensile steel body and jamb construction to maximize protection against pry attacks.
- ½" solid steel door.
- U.L. Group II combo lock (C), U.L. listed dual nose keylock (K).
- Three 1" diameter chromed steel locking bolts.
- Bolt detent system engages boltwork automatically.
- Auxiliary spring-loaded relocking device.
- Lock and relock protected by large carburized hardplate.
- Four anchor bolt holes.
- Adjustable shelf provided.
- Also available with optional deposit slot (s). (shown above) Slot size: ½" H x 6 W"

Model	Inside Dim H x W x D	Outside Dim* H x W x D	Clear Door H x W	Cu. In.	Wt	Shelves
BWB2020	19-3/4 x 19-3/4 x 17	20 x 20 x 20	14-3/4 x 16-1/4	6,631	154	1
BWB3020	29-3/4 x 19-3/4 x 17	30 x 20 x 20	24-3/4 x 16-1/4	9,988	218	2
BWB4020	39-3/4 x 19-3/4 x 17	40 x 20 x 20	34-3/4 x 16-1/4	13,346	272	3
BWB2025	19-3/4 x 24-3/4 x 22	20 x 25 x 25	14-3/4 x 21-1/4	10,754	235	1
BWB3025	29-3/4 x 24-3/4 x 22	30 x 25 x 25	24-3/4 x 21-1/4	16,198	306	2
BWB4025	39-3/4 x 24-3/4 x 22	40 x 25 x 25	34-3/4 x 21-1/4	21,644	440	3
MS1414	13-3/4 x 13-3/4 x 11	14 x 14 x 14	9-3/4 x 9-3/4	2080	67	1

\*Add 2" to outside depth for handle, dial and hinge projection.



**DS SERIES - "B" RATE ROTARY AND FRONT LOADING**

**AMSEC'S DS SERIES DEPOSITORY SAFES**

are designed to provide immediate deposits and storage for cash, jewelry and miscellaneous valuables.

Deposits can be made to a locked compartment via a top-loading rotary hopper, a reverse or a front-loading deposit door.



**DSC2014KC**



**DSF2714K**



**REVERSE HOPPER  
DSR2014 WITH ESL10XL**



**DSF2014  
WITH ESL10XL LOCK**



**DSF3214CC**

**STANDARD FEATURES**

**BODY:**

- Strong, formed "B" Rate construction made of A36 solid steel plate for improved security and appearance.
- Formed door jamb for increased resistance to sledgehammer attack.
- Four anchor bolt holes are standard.

**DOOR - MODEL NUMBERS:  
2014, 2714 AND 3214**

- 1/2" thick A36 solid steel plate, recessed 1/2" to increase resistance to pry attack.
- U.L. Group II combo lock (C), U.L. listed dual nose keylock (K).
- Optional electronic locks available.
- Three 1" diameter chromed steel locking bolts.
- Bolt detent system engages boltwork automatically.
- Auxiliary spring-loaded reloading device.
- Lock and reload protected by large carburized hardplate.

**HOPPER:**

- 2014 is available w/reverse hopper.
- Large package sizes:  
(Top Load Rotary):  
4 3/4"D x 4 3/4"W x 10"L  
(Front/Reverse Load):  
4"D x 2 3/4"W x 10 1/2"L
- Recessed, heavy duty 3/16" construction (1/4" door).
- Protected by dual "anti-fish" baffles.

Model †	Inside Dimension H x W x D	Outside Dim* H x W x D	Clear Door H x W	Cu. In. Capacity	Wt.
DST2014	11-1/2 x 13-3/4 x 11	20-1/4 x 14 x 14	9-3/4 x 9-3/4	1,739	90
DSF2014	10 x 13-3/4 x 11	20-1/4 x 14 x 14	9-3/4 x 9-3/4	1513	82
DSR2014	10 x 13-3/4 x 11	20-1/4 x 14 x 14	9-3/4 x 9-3/4	1513	82
DSC2014KC **	BT 10-1/4 x 13-3/4 x 11 TP 6-7/8 x 13-3/4 x 12-3/8	27-1/4 x 14 x 14	BOT 9-3/4 x 9-3/4 TOP 6 x 10-3/8	1513 1127	104
DST2714	18-1/2 x 13-3/4 x 11	27-1/4 x 14 x 14	9-3/4 x 9-3/4	2798	104
DSF2714	17-1/4 x 13-3/4 x 11	27-1/4 x 14 x 14	9-3/4 x 9-3/4	2609	95
DST3214	TP 12-1/4 x 13-3/4 x 11 BT 11-1/4 x 13-3/4 x 11	32-1/4 x 14 x 14	9-3/4 x 9-3/4	1664 1890	148
DSF3214	TP 11-1/4 x 13-3/4 x 11 BT 12-1/2 x 13-3/4 x 11	32-1/4 x 14 x 14	9-3/4 x 9-3/4	1815 1702	144

**IMPORTANT:**  
AMSEC depository safes are recommended for an operation that requires a non-returnable deposit such as armored car companies, convenience stores, restaurants, etc. The top locker is not meant for overnight storage of cash or valuables.

†Specify Prefix: T=Top Loading, F=Front Loading, R=Reverse Hopper, K=Key Lock, C=Combo Lock, E=Electronic Lock  
\*Add 2" to outside depth for dial and handle projection.  
\*\*Camlock on locker, combination on deposit safe.



# UNDERCOUNTER SAFES

UNDERCOUNTER SAFES

AMSEC'S UNDERCOUNTER SAFES limit excess cash register funds by providing instant protection for interim deposits of cash or checks via the anti-fish deposit slot. Securely positioning the safe next to the cash register limits exposed cash and reduces the threat of robbery and internal theft. Adaptable for multi-unit installation use, ideal for gun control, staff use, athletics clubs, security areas and much more.



**(LOCK OPTION -2)  
TB0610-2**  
Medeco® single key camlock



**(LOCK OPTION -7)  
TB0610-7**  
Best removable core key lock (core not included)



**(LOCK OPTION -1)  
TB0610-1**  
Chicago single key camlock



**(LOCK OPTION -4)  
TB0610-4**  
Dual custody safe deposit key lock

**FEATURES:**

- Heavy gauge solid steel construction.
- Full width deposit slot over door equipped with an "anti-fish" saw tooth baffle to guard against pilferage or fishing.
- Heavy-duty piano hinges.
- Available with six different lock options to fit your specialized security requirements.
- Units can be bolted together utilizing bolt holes.
- Interchangeable doors allow flexible means of changing locking mechanisms without replacing the entire unit.
- Two anchor holes provided on all four sides.
- Attractive and durable powder coated black finish.

**LOCK OPTIONS:**

- Chicago single key camlock equipped with two keys. (Lock option -1)
- Chicago 7 pin radial key camlock, equipped with 2 keys. (Lock option 1T)
- Medeco® U.L. listed high security single key camlock supplied with two keys. Medeco's restricted keyways protect against unauthorized key duplication. (Lock option -2)
- Dual custody safe deposit key lock (two keys required to open safe). (Lock option -4)
- Best removable core key lock supplied without core. A removable core system lets you change the combination of any lock in seconds and can easily expand to include new facilities. Supplied without core. (Lock option -7, without core).
- Optional custom key control systems designed to your security requirements:
  - 1) Master Keyed
  - 2) Keyed Alike
  - 3) Keyed Different



**HEAVY DUTY SERIES  
MODEL K1**

- 1/4" thick A36 solid steel plate hinged door.
- Full width slot over door.
- A saw tooth baffle guards against pilferage or fishing.
- Your choice of a single key Medeco® lock (K-1), or a Chicago single key lock (K-1A).
- "B" Rate steel construction.
- May be installed vertically or horizontally.
- May be mounted on or under counter as space permits.
- Durable, impact resistant Charcoal Gray textured finish.

Model	Inside Dimension H x W x D	Outside Dimension H x W x D	Clear Door H x W	Cu. In.	Wt.
TB0610	5-7/8 x 5-7/8 x 8-3/8	6 x 6 x 10	5-7/8 x 5	289	8
K1	5-5/8 x 5-5/8 x 10	6 x 6 x 12	3-13/16 x 5	316	16

NOTE: Models TB0610 is available with the AMSEC ESL Slam lock. (Factory installed primary lock.)

**IMPORTANT:**

AMSEC Undercounter safes are recommended for an operation that requires a non-returnable deposit. These safes are not meant for overnight storage of cash

**PHARMACY AND NARCOTICS SAFES**



PSSW-38

**PSSW-38  
WITH ADDITIONAL SHELF AND TWO  
OPTIONAL DRAWERS**

AMSEC's complete line of **PHARMACY AND NARCOTICS SAFES** offer a great solution for keeping your high-value, high-target medications and facility safe from the devastating occurrence of a robbery, burglary or internal theft. Choose from several models that are ideal for small to larger sized pharmacies, hospitals or health care facilities.



PSE-14



PSK-14

**Pharmacy Safe Features:**

- AMSEC Pharmacy safes are designed to easily replace a standard large or small wooden pharmacy cabinet.
- Six models to choose from.
- 77" or 38-1/2" tall with a 12", 18" or 24" depth.
- Two outer doors made of high strength steel.
- Two-way locking system.
- Auxiliary spring-loaded relock device.
- 4 heavy duty hinges.
- 4 anchor holes.
- Pharmacy White textured finish.
- Made in the USA.
- Optional drawers available. Each drawer is equipped with adjustable compartments, heavy-duty ball bearing suspension glides and is secured by the lock of your choice.

**NS Series Narcotic Safe Features:**

- 1/2" thick solid steel door.
- Roll-out narcotic drawers with removable dividers.
- Three sizes to choose from.
- Large carburized hardplate.
- Auxiliary spring-loaded relock device.
- 3-way locking system.
- Five massive 1" locking bolts.
- Bolt detent system engages bolts automatically.
- Door mounted storage compartments.
- Four anchor holes.
- Pharmacy White or black textured finishes.

**Pharmacy & Narcotic Safe Lock Options:**

- SafeWizard II Electronic lock. A full featured Access Control System that controls the outer door and up to 11 interior drawers. For more information see page 41.
- ESLAudit Electronic lock. A robust Access Control System that controls the outer door and 1 interior drawer. For more information see page 42.
- ESL20XL Electronic lock. Controls the outer door. For more information see page 43.
- A high security Medeco key lock that controls the outer door. Only offered on Pharmacy safes.
- Other lock options available upon request.

Model	Outside Dim.	Wt. Lbs	Shelves
<b>Tall Pharmacy Safes</b>			
18	77"H x 36-1/4"W x 12"D	517	5
28	77"H x 36-1/4"W x 18"D	565	5
38	77"H x 36-1/4"W x 24"D	613	5
<b>Small Pharmacy Safes</b>			
9	38-1/2"H x 36-1/4"W x 12"D	250	2
14	38-1/2"H x 36-1/4"W x 18"D	286	2
19	38-1/2"H x 36-1/4"W x 24"D	324	2
<b>Narcotic Safes</b>			
NS2020	20"H x 20"W x 20"D	217	1
NS3020	30"H x 20"W x 20"D	344	2
NS4020	40"H x 20"W x 20"D	461	3



NS3020W



For a detailed chart of sizes and specs for these models, please see the AMSEC Price List, Page 13.



# AMVAULTX6 TL-30X6 HIGH SECURITY SAFE

AMVAULTX6 TL-30X6



CFX582820

The new Amvaultx6 U.L. Listed TL-30x6, six-sided high security composite safes are made in the United States using the latest testing procedures set forth by Underwriters Laboratories.

The new revolutionary Amvaultx6 is constructed with a 3" defense barrier of inner and outer steel plates enclosing a unique interlocking heavy duty steel barrier, high strength concrete exceeding 12,000 PSI and a high-density high-strength ceramic matrix.

The high density insulating materials incorporated in the door and body also insure two hours of certified fire protection. The superior design and craftsmanship make the new Amvaultx6 impervious to burglary attacks attempted by the most sophisticated equipment utilized today and the vaults contents against intense fires.



Model	Inside Dimension	Outside Dimension*	Clear Door	Cu. Ft.	Wt	Door Thickness	Shelves
CFX252016	25 x 20 x 16	31 x 26 x 25-1/4	25 x 20	4.6	1,433	6"	1
CFX352020	35 x 20 x 20	41 x 26 x 29-1/4	35 x 20	8.1	1,946	6"	2
CFX452020	45 x 20 x 20	51 x 26 x 29-1/4	45 x 20	10.4	2,343	6"	3
CFX582820	58 x 28 x 20	64 x 34 x 29-1/4	58 x 28	18.8	3,418	6"	4
CFX703620	70 x 36 x 20	76 x 42 x 29-1/4	70 x 36	29.2	4,578	6"	4

\* Add 2-3/8" to outside depth for handle, dial and hinge projection. Optional 3-way boltwork available on the CFX line.

# ACF TL-30 FIRE RATED DEPOSITORY SAFE

ACF TL-30 SERIES



ACF4824DS SHOWN WITH OPTIONAL ESL20XL ELECTRONIC LOCKS AND AUXILIARY KEY-OP LOCK

AMSEC's ACF TL-30 **TWO DOOR DEPOSITORY SAFE** offers complete cash management versatility for any operation that requires a nonreturnable deposit such as armored car companies, convenience stores, restaurants, etc. The U.L. listed TL-30 composite construction offers peace of mind when overnight protection is required.

In addition to the outstanding features listed under ACF TL-30 Money Chest, the ACF4824DS Depository safe also offers:

### TOP DEPOSIT / STORAGE COMPARTMENT

- Outer door equipped with a U.L. listed Group 2M combination lock and chrome plated front read dial.
- Large storage capacity: accommodates up to nine cash register trays.
- Large 3" x 18" deposit chute is protected by an "anti-fish", saw-tooth, hinged baffle.
- Two adjustable shelves.
- Door mounted four-opening rolled coin storage rack.

### Options:

- Electronic locks, Group 1 and 1R locks.
- Dual combination locks (Receiving compartment only).
- Spyproof dial, Keylock dial.
- Modular alarm.
- Interior lockers, Interior drawers, Adjustable shelves.
- Custom sizes/designs quoted upon request.
- Access Control Systems.

### BOTTOM RECEIVING COMPARTMENT

- Outer door equipped with a U.L. listed Group 2M combination lock, chrome plated front read dial and an auxiliary key-op lock for dual control or armored car pick up.

### FINISH

- Available in Black, Parchment, Standard Gray, Blue Gray, Romanesque Gray, Charcoal Gray, Granite, Sandstone or Chocolate Brown textured finish.



Model	Inside Dimension	Outside Dimension*	Clear Door	Cu. In.	Wt
ACF4824DS	TOP 26 x 18 x 14 BTM 14 x 18 x 17	47-3/4 x 24 1/2 x 26	25 x 16-3/4 13 x 16-3/4	6,552 4,284	1746

\* Add 2" to outside depth for handle, dial and hinge projection. Standard with two shelves. Optional 3-way boltwork available on the ACF line, retail price \$160.00. Custom size/design quoted upon request.

# AMVAULT FIRE RATED COMPOSITE SAFES



During extreme testing procedures, **AMVAULT COMPOSITE SAFES** demonstrated the ability to withstand severe attacks by experienced U.L. experts using powerful tools such as sledgehammers, power saws, carbide disc cutters, drills, etc., and without fail, were awarded the U.L. TL-15 and TL-30 labels.

Besides withstanding the most concentrated attacks by sophisticated burglars, each AMVAULT safe offers a Two Hour, 350° F factory fire test certification, ensuring the protection of the vault's contents against intense fires.



**CF6528  
SHOWN WITH  
OPTIONAL INTERIOR LOCKERS**

**1850°**

AMVAULT  
2-Hour,  
350° F  
rating  
(Factory  
tested at  
1850°

**1200°**

Average  
House Fire

**450° F**

Paper Chars

**350° F**

Interior of an AMSEC Safe



**CF3524**



**CE2518 WITH OPTIONAL  
STOR-IT CABINET**

**OPTIONAL STOR-IT  
CABINETS AVAILABLE  
IN CE AND CF MODELS:  
2518 / 3524 / 5524 / 6528 / 7236**

Fully upholstered safe interior kits available for these models.

See Page 10 for more details.

**OPTIONAL PREMIUM UPGRADE  
PACKAGE AVAILABLE.  
SEE PAGE 10 FOR DETAILS**

## FEATURES:

### DOOR:

- Overall thickness of 6" and is constructed with a 3" defense barrier of outer and inner steel plates creating a single structure enclosing a unique, high density fire and burglary resistant composite material.
- Defense barrier houses a proprietary amalgamation of nuggets and steel fibers to withstand concentrated attacks with the most sophisticated equipment used by burglars today.
- Heavy duty pull handle standard on all CE/CF Models

### BODY:

- The AmVault formed body has a total protective thickness of 3½" enclosing a high density fire resistant composite material with nuggets and steel fibers.
- A reinforced drill resistant door frame protects the door and each individual bolt chamber from severe side attacks.
- A proprietary inner barrier protects against peeling attacks.
- High strength adjustable shelves with powder coated parchment finish.

### FIRE ENDURANCE:

- Two hour, 350°F factory fire rating. Tested at temperatures up to 1850°F

### LOCKING MECHANISM:

- Equipped with six or ten massive 1½" diameter chrome plated solid steel locking bolts. Each bolt moves deep into the body's protected bolt chambers.
- Entire boltwork mechanism is also protected by a spring operated boltwork detent system. Bolts stay in the retracted position when the door is opened and automatically engage when the door is closed.

## THREE-WAY BOLTWORK OPTION (TL-30 ONLY):

- Safes can be equipped with a three way active boltwork mechanism engaging the bolts horizontally and vertically into the body of the safe.

### LOCKS:

- Equipped with a U.L. listed Group 2M key changeable combination lock. The lock is protected by a massive drill shattering hard plate and two additional spring-loaded devices.

### HINGES:

- Offers a vertical height adjustment and utilizes an oil impregnated bearing ensuring easy door operation.

## OPTIONAL AUXILIARY KEY LOCK:

- U.L. listed, high security auxiliary key lock is also available on all AMVAULT safes (except Model 1814). Lock is equipped with 2 keys and escutcheon plate.
- An additional spring-loaded relock device protecting lock against punch attacks.

## OPTIONAL GLASS RELOCKING MECHANISM

- Incorporated into the AMVAULT TL-30 auxiliary key lock is an optional high security tempered glass relock mechanism with a remotely and randomly placed "cross locking" relocking bolt and thermal cords to protect against torch attacks.
- In the event of an attack by tools, torches, or explosives, the glass will shatter activating the highly sophisticated relock mechanism.
- Utilizing the glass relock mechanism can offer up to a total of six different relock devices offering the ultimate in high security protection.





**SAFE SPECIFICATIONS**

AMVAULT TL-30 AND TL-15

AMVAULT High Security Composite safes have passed Underwriter's Laboratories most recent testing procedures ensuring you today's best protection. AMVAULT TL-15 and TL-30 U.L. listed composite safes qualify for Mercantile & Broadform Insurance Class ER (TL-15) and F (TL-30) with a Bank Rating of BR (TL-15) and G (TL-30). Two Hour Class 350°F manufacturers' fire label. Standard finish is Parchment. Other colors available on request.



**STANDARD AMVAULT ESCUTCHEON PLATE**  
Tri-spoke handle and pull handle standard on all models except CE/CF1814.

Model Number	Inside Dimension	Outside Dimension*	Cubic Feet	Weight	Interior Shelves	Door Swing		
	H x W x D	H x W x D				A	B	C
<b>TL-15</b>								
CE1814 **	18 x 14 x 12	25 x 21 x 21½	1.8	710	1	14	36	39½
CE2518	25 x 18 x 16	32 x 25 x 25½	4.2	1,105	1	18	44	47½
CE3524	35 x 24 x 20	42 x 31 x 29½	9.7	1,674	2	24	56	57½
CE4524	45 x 24 x 20	52 x 31 x 29½	12.5	2,003	3	24	56	57½
CE5524	55 x 24 x 20	62 x 31 x 29½	15.3	2,343	3	24	56	57½
CE6528	65 x 28 x 20	72 x 35 x 29½	21.1	3,153	4	28	64	61½
CE7236	72 x 36 x 23	79 x 43 x 32½	34.5	3,880	4	36	80	72½
<b>TL-30</b>								
CF1814 **	18 x 14 x 12	25 x 21 x 21½	1.8	758	1	14	36	39½
CF2518	25 x 18 x 16	32 x 25 x 25½	4.2	1,195	1	18	44	47½
CF3524	35 x 24 x 20	42 x 31 x 29½	9.7	1,908	2	24	56	57½
CF4524	45 x 24 x 20	52 x 31 x 29½	12.5	2,311	3	24	56	57½
CF5524	55 x 24 x 20	62 x 31 x 29½	15.3	2,679	3	24	56	57½
CF6528	65 x 28 x 20	72 x 35 x 29½	21.1	3,359	4	28	64	61½
CF7236	72 x 36 x 23	79 x 43 x 32½	34.5	4,426	4	36	80	72½

\* Add 2-3/8" to outside depth for handle, dial and hinge projection.  
\*\*Models 1814 can not be equipped with an auxiliary lock, 3-way boltwork or glass relock mechanism. Left Swing Models: After model #, use suffix L.

**DOOR SWING PROJECTIONS**

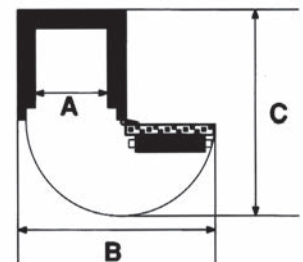

**UNDERWRITERS LABORATORIES' BURGLARY RATING CLASSIFICATION**

**U.L. Label — Burglary Classification TL-15:**

Signifies a combination-locked safe designed to offer a limited degree of protection against attack by common mechanical and electrical hand tools and any combination of these means.

**Construction Requirements**

- U.L. listed Group 2M, 1 or 1R combination lock or Type 1 Electronic lock.
- 750 lbs. minimum or comes with instructions for anchoring in a larger safe, concrete blocks or on the premises where used.
- Body walls of material equivalent to at least 1" open hearth steel with a minimum tensile strength of 50,000 P.S.I.
- Walls fastened in a manner equivalent to continuous ¼" penetration weld of open hearth steel with minimum tensile strength of 50,000 P.S.I.

- One hole ¼" or less, to accommodate electrical conductors arranged to have no direct view of the door or locking mechanism.

**Performance Requirements**

Successfully resist entry\* for a net working time of 15 minutes when attacked with common hand tools, picking tools, mechanical or portable electric tools, grinding points, carbide drills and pressure applying devices or mechanisms.

**U.L. Label —Burglary Classification TL-30:**

Signifies a combination-locked safe designed to offer a moderate degree of protection against attack by common mechanical and electrical hand tools and any combination of these means.

**Construction Requirements**

Same as TL-15



**Performance Requirements**

Successfully resist entry\* for a net working time of 30 minutes when attacked with common hand tools, picking tools, mechanical or portable electric tools, grinding points, carbide drills and pressure applying devices or mechanisms, abrasive cutting wheels and power saws.

\*Entry=Safes classed as TL-15 — opening the door or making a six square inch opening entirely through the door or front face. Safes classed as TL-30 — opening the door or making a six square inch opening entirely through the door or front face.



## DXE / DXF AND CDXE / CDXF U.L. LISTED

AMSEC TL-15 and TL-30 U.L. Listed **MONEY CHESTS** qualify for Mercantile & Broadform Insurance Class ER (TL-15) and F (TL-30) with a banking rating of BR (TL-15) and G (TL-30). AMSEC MONEY CHESTS offer the highest level of security available with many outstanding features and a wide range of options.



**CDXE2020**  
TL-30 Composite  
Body and  
Plate Door



**DXE2020**  
TL-15 Plate Body  
and Door

## FEATURES

### DOOR:

- DXE and CDXE models are TL-15 rated constructed of ½" thick high-strength solid steel plate.
- DXF and CDXF models are TL-30 constructed of 1¾" thick laminated steel with a special hardened drill resistant plate.
- Oil impregnated bronze bearing hinges.

### BODY:

- DXE models: Consist of ½" thick steel plate (100,000 P.S.I. minimum tensile strength). All external seams are beveled and continuously welded.
- DXF models: Models under 50" in height consist of ½" thick steel plate with 100,000 P.S.I. minimum tensile strength. DXF models over 50" in height constructed of ¾" thick steel plate with 75,000 P.S.I. minimum tensile strength. All external seams are beveled and continuously welded.
- CDXE and CDXF models: consist of 3¼" thick body constructed of inner and outer steel plates enclosing a high density composite material.
- Shelf strips installed allowing shelf adjustment. Shelves optional.

### LOCKING MECHANISM:

- U.L. listed Group 2M key changeable combination lock, with relock and 1 million possible combinations.
- Single auxiliary spring loaded relocking device, activated by a punching attack.

- Locks and relocks protected by a patented active hardplate.
- A handle activated locking mechanism consisting of two to six 1" chromed steel locking bolts.
- Five boltwork sizes allow AMSEC to build units from 12" (10½" for DXE/DXF) to 88" high, widths from 14" to 41".
- Solid steel dead bar prevents door removal if hinges are removed during a forced entry attempt.
- Compact locking mechanism and boltwork cover allow for optional door mounted coin racks.

### HINGES:

- Fabricated from high strength steel with precision machined alloy dowel pins.
- Oil impregnated bronze bearing assures easy opening doors and reduced maintenance.
- Vertical height adjustment.

### FINISH:

- Available in Satin Black, Parchment, Standard Gray, Blue Gray, Romanesque Gray, Charcoal Gray, Granite, Sandstone or Chocolate Brown textured finish.

### OPTIONS:

- Spyproof dial
- Key lock dial
- Coin racks
- Managers lockers
- Interior lockers
- Interior drawers
- Adjustable shelves
- Group 1 and 1R locks
- Electronic locks
- Access Control Systems
- Auxiliary Key-Op locks
- Dual combination locks (some models)
- 144 hour timelock
- 15 minute time delay lock
- External day lock
- Claddings
- Anchor bolt assembly
- Left swing door
- Internal rotary hopper
- Internal deposit slot
- Internal deposit chutes
- Hidden compartments
- Modular alarm
- Hold up duress alarm
- Special sizes
- Custom colors

**FOR A DETAILED CHART OF SIZES AND SPECS FOR THESE MODELS, PLEASE SEE THE AMSEC PRICE LIST, PAGE 12.**



# ACF TL-30 U.L. LISTED FIRE RATED MONEY CHEST

ACF TL-30 SERIES



**ACF4024  
SHOWN WITH  
AUXILIARY LOCK**

AMSEC TL-15 and TL-30 U.L. Listed **MONEY CHESTS** qualify for Mercantile & Broadform Insurance Class ER (TL-15) and F (TL-30) with a banking rating of BR (TL-15) and G (TL-30). AMSEC MONEY CHESTS offer the highest level of security available with many outstanding features and a wide range of options.

## FEATURES:

### DOOR:

- 5½" thick door constructed of outer and inner steel plates enclosing a high density proprietary composite material.
- Two hour, 350°F factory fire rating. Tested at temperatures up to 1850°F.

### BODY:

- 3¼" thick body constructed of inner and outer steel plates enclosing a high density proprietary composite material.
- Door and inner jamb surrounded by thick solid steel bars.
- Adjustable shelves.

### LOCKING MECHANISM:

- U.L. listed Group 2M key changeable lock, with relock and 1 million possible combinations.
- Single auxiliary spring-loaded relocking device, activated by a punching attack.

- Locks and relocks protected by a large proprietary drill shattering composite hardplate.
- A handle activated locking mechanism consisting of three to five 1" diameter chromed steel locking bolts.
- Five boltwork sizes allow AMSEC to build units from 12" to 82" high, widths from 18" to 48" (interior dimensions).
- Solid steel dead bars prevent door removal if hinges are removed during a forced entry attempt.
- Compact locking mechanism allows for optional door mounted coin racks.

### HINGES:

- Ball bearing hinges fabricated from high strength steel.
- Precision machined alloy dowel pins.
- Oil impregnated bronze bearing assures easy opening doors and reduced maintenance.
- Vertical height adjustment.

### FINISH:

- Available in Satin Black, Parchment, Standard Gray, Blue Gray, Romanesque Gray, Charcoal Gray, Granite, Sandstone or Chocolate Brown textured finish.

### OPTIONS:

- Spyproof dial
- Key lock dial
- Coin racks
- Managers lockers
- Interior lockers
- Interior drawers
- Adjustable shelves
- Group 1 and 1R locks
- Electronic locks
- Access Control Systems
- Auxiliary Key-Op locks
- Dual combination locks (some models)
- 144 hour timelock
- 15 minute time delay lock
- External day lock
- Anchor bolt assembly
- Left swing door
- Internal rotary hopper
- Internal deposit slot
- Internal deposit chutes
- Hidden compartments
- Modular alarm
- Hold up duress alarm
- Special sizes
- Custom colors
- Custom designs



Model	Inside Dimension	Outside Dimension*	Clear Door	Cu. In.	Wt
ACF 2020	20 x 20 x 20	26-3/4 x 26½ x 29	19 x 18-3/4	8,000	1,069
ACF 2020XD	20 x 20 x 24	26-3/4 x 26½ x 33	19 x 18-3/4	9,600	1,170
ACF 3020	30 X 20 X 20	36-3/4 x 26½ x 29	29 x 18-3/4	12,000	1,369
ACF 3020XD	30 X 20 X 24	36-3/4 x 26½ x 33	29 x 18-3/4	14,400	1,492
ACF 4024	40 X 24 X 20	46-3/4 x 30½ x 29	39 x 22-3/4	19,200	1,849
ACF 4024XD	40 X 24 X 24	46-3/4 x 30½ x 33	39 x 22-3/4	23,040	2,003
ACF 5024	50 X 24 X 20	56-3/4 x 30½ x 29	49 x 22-3/4	24,000	2,176
ACF 5024XD	50 X 24 X 24	56-3/4 x 30½ x 33	49 x 22-3/4	28,800	2,351
ACF 6030	60 X 30 X 20	66-3/4 x 36½ x 29	59 x 28-3/4	36,000	2,847
ACF 6030XD	60 X 30 X 26	66-3/4 x 36½ x 35	59 x 28-3/4	46,800	3,162

\* Add 2" to outside depth for handle, dial and hinge projection. Standard with two shelves.  
Optional 3-way boltwork available on the ACF line, retail price \$160.00. Custom size/design quoted upon request.



**BLB AND BLC SERIES**

AMSEC "B" AND "C" RATE SECURITY CHESTS are designed to provide secure storage at an economical price. In addition to meeting the requirements of the Insurance Offices Manual of Burglary Insurance, these units offer an appearance and many features similar to AMSEC'S higher rated TL-15 models.



**BLC3018**

**STANDARD FEATURES**

**DOOR:**

- 1" ("C" Rate), or ½" ("B" Rate) steel pry-resistant recessed door.
- U.L. listed Group II key changeable lock, with relock and 1 million possible combinations.
- Additional spring loaded reloading device, activated by a punching attack.
- Locks and relocks protected by a large carburized hardplate.
- A handle activated locking mechanism consisting of three 1" chromed steel locking bolts. (five in BLB and BLC4024 models).
- Solid steel full length dead bar prevents door removal if hinges are removed during a forced entry attempt.
- Adjustable ball bearing hinges.

**BODY:**

- ½" ("C" rate) or ¼" ("B" Rate) solid steel bodies.
- Body reinforcing frame gives the appearance of 1" thick walls to discourage attack.
- Adjustable shelves.
- Attractive Gray textured finish. Other colors available.
- Custom sizes, interior options and high security features available.
- Left swing door optional.

**B-Rate Premium Free-Standing Security Chest**

Model	Inside Dim H x W x D	Outside Dim* H x W x D	Clear Door H x W	Cu. In. Capacity	Wt	Shelves
BLB2018	20 x 18 x 12	20½ x 18½ x 15	18 x 16	4,320	218	2
BLB3018	30 x 18 x 16	30½ x 18½ x 19	28 x 16	8,640	312	2
BLB3024	30 x 24 x 20	30½ x 24½ x 23	28 x 22	14,400	360	3
BLB4024	40 x 24 x 20	40½ x 24½ x 23	38 x 22	19,200	445	4

\*Add 2" to outside depth for handle, dial and hinge projection. Custom design available on request.

**C-Rate Premium Free-Standing Security Chest**

Model	Inside Dim H x W x D	Outside Dim* H x W x D	Clear Door H x W	Cu. In. Capacity	Wt	Shelves
BLC2018	20 x 18 x 12	21 x 19 x 16	18½ x 16½	4,320	370	2
BLC3018	30 x 18 x 16	31 x 19 x 20	28½ x 16½	8,640	550	2
BLC3024	30 x 24 x 20	31 x 25 x 24	28½ x 22½	14,400	740	3
BLC4024	40 x 24 x 20	41 x 25 x 24	38½ x 22½	19,200	925	4

\*Add 2" to outside depth for handle, dial and hinge projection. Custom design available on request.



**TELLER LOCKERS**

TELLER LOCKERS



**FEATURES:**

**Body:**

- 16"H x 32-5/8" W x 24" D, 1/4" solid steel construction.

**Door:**

- 1/4" solid steel, hinged from center divider.

**Hinge:**

- Solid steel continuous hinge.

**Color:**

- Available in Satin Black, Parchment, Standard Gray, Blue Gray, Romanesque Gray, Charcoal Gray, Granite, Sandstone or Chocolate Brown textured finish.

**Locks:**

- U.L. listed double nose and single nose safe deposit locks or Medeco® camlocks standard. Combination locks optional extra.

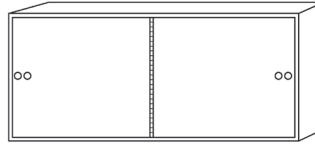

**ATL-2**  
**WEIGHT: 240 LBS.**

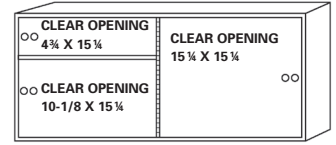

**ATL-3R**  
**WEIGHT: 255 LBS.**

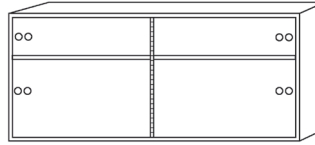

**ATL-4**  
**WEIGHT: 270 LBS.**

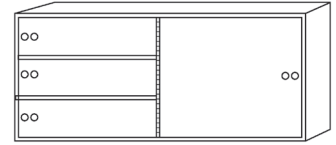

**ATL-4R**  
**WEIGHT: 270 LBS.**

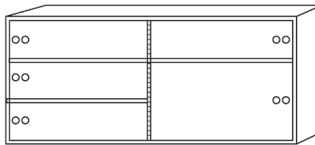

**ATL-5R**  
**WEIGHT: 285 LBS.**

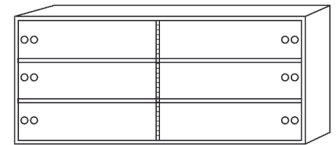

**ATL-6**  
**WEIGHT: 295 LBS.**

**CUSTOM SAFES**

CUSTOM SAFES

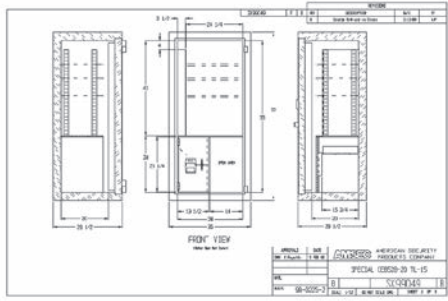

AMSEC specializes in manufacturing CUSTOM SAFES for supermarkets, banks, restaurants, convenience stores, gas stations, hotels, mini-marts and other businesses. With over 70 years experience building custom safes, AMSEC has the knowledge and expertise to design a safe to meet your cash handling requirements. Our engineering department is equipped with the latest in computer-aided design (CAD) systems for rapid creation of detailed sales sketches, concept drawings, final product prints and design modifications to help you visualize how the safe will look and function. Custom safes are available in every insurance classification from "B" Rate to U.L. listed TL-30 models.

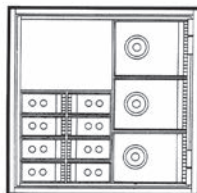
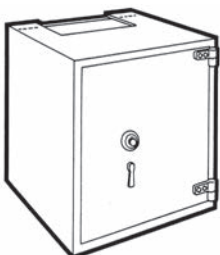
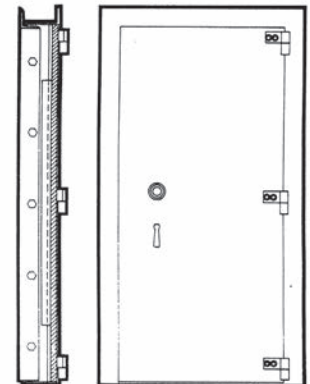
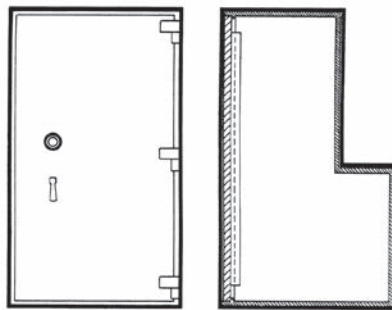
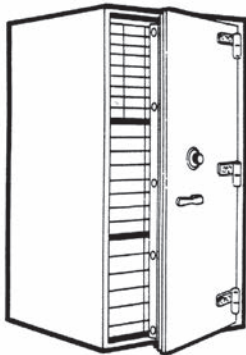

**OPTIONAL EXTRAS**



**Interior Drawers**

All drawers are commercial quality, heavy steel construction. Available in letter, legal and document sizes. Each is furnished with handle and key lock. All drawer capacities are 150 lbs. and come with a heavy duty latch removable ball bearing suspension.

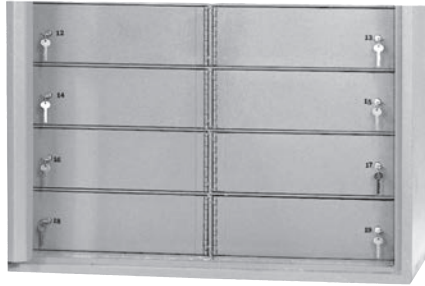

**Interior Lockers**

AMSEC offers a wide variety of standard interior locker compartments to fit your needs. Standard lockers are constructed of 10 gauge or 1/4" solid steel. Options include slotted doors, combination locks and high security key locks.

**Slotted Doors**

Slotted doors are also available on freestanding plate safes, freestanding clad, composite chests, interior lockers and interior drawers.

**Note:** Safes with slotted doors are not recommended for overnight storage.



**STAR "C" RATE SLOTTED ROUND DOOR**  
with 3/8" x 3 1/2" slot



**SUPER BRUTE "B" AND "CB" RATE SQUARE HINGED DOOR**

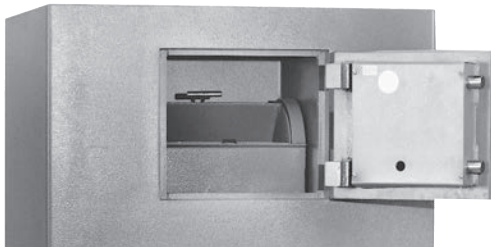

**Interior/Exterior Hopper**

Available in three different package sizes ranging from 5 3/4" D x 3 1/2" W x 8 3/4" L to 7" D x 4 1/2" W x 10 3/4" L.

Hoppers can be installed on the interior or exterior of plate, clad or composite safes.



**Modular Alarm System**

Detects vibration, heat and door openings. Heat indicator activates alarm when torch attack occurs. Internal magnetic door contact detects door opening. Internal vibration sensor activates alarm if safe is moved or during drill attack.

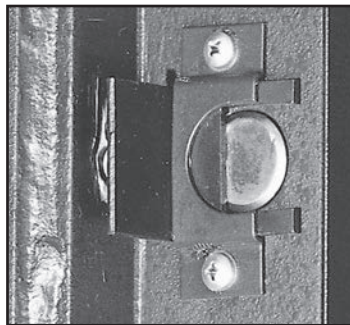

**Locking Bolt Detent**

Keeps locking bolts retracted when door is in open position. Prevents damage to safe body and boltwork mechanism caused by accidental door closure with bolts extended.



**Coin Racks**

For organized storage of coins. Mounted on inside safe door. Available with four or six compartments.



**AMSEC SAFEWIZARD II®**

**ELECTRONIC LOCKS**



**SafeWizard II is the most flexible and powerful safe access control system available.**

**Security**

- All components communicate through an encrypted network
- Supports dual control and armored car pickups
- Supports time delay as a deterrent to robberies
- Supports time lock restricted access to defined operating hours
- 120,000-record audit trail
- Supports up to 500 users, each of whom can have unique privileges
- PIN code and/or Electronic keys for authentication of users
- Door and bolt sensors detect if a door has been left open or has been tampered with
- Battery backup for 8 hours of power-out operation
- Backup database secured inside of safe
- U.L. Type 1 Listed

**Flexibility**

- Network access via Ethernet or Wi-Fi connection
- Local firmware upgrades via USB
- Supports up to 12 door locks and one deposit lock
- Multiple lock designs support access control of safe doors, lockers and drawers
- Each lock is individually configured for all access control parameters and user access

**Remote Management**

- Manage system configuration and users through the cloud
- Remote firmware upgrades
- Sends alerts via text message or e-mail
- Safes can be managed individually, as a group or for the whole enterprise
- Flexible reporting

**Additional Features**

- Wrong try count penalty lockout
- Auto purge idle users option
- Forced PIN changes
- Duress/hold-up alarm
- Burglary alarm output
- Holiday schedule, up to 16 events per year
- Automatic daylight savings
- Deposit tracking system
- Built-in system diagnostics
- English, Spanish, French and German (coming soon)





**ESLAUDIT**



**ESLAudit makes it easy to manage safe access with it's integrated USB Port.**

**Security**

- All components communicate through an encrypted network
- Supports dual control and armored car pickups
- Supports time delay as a deterrent to robberies
- Supports time lock restricted access to defined operating hours
- Supports alarm output or duress alarm
- 2,000-record audit trail
- Supports up to 40 users, each of whom can have unique privileges
- PIN code and/or electronic keys for user authentication
- Optional door sensor detects if door is left open
- Back-up database secured inside of safe

**Flexibility**

- Retrofits most mechanical or electronic locks
- 3 unique lock designs
- Controls 1 or 2 doors
- Safe doors can be configured in an inner/outer door configuration
- Authentication options: PIN and/or AMSEC e-Key
- 9-volt battery and optional AC power
- Optional remote time delay indicator
- Update firmware via USB port

**Powerful PC application**

- Manage users
- View and store audit trails
- Manage system configuration
- Manage door settings

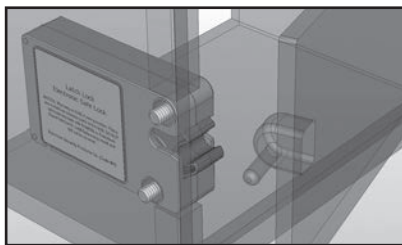

LATCH LOCK

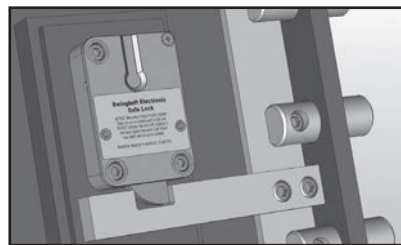

SWING BOLT LOCK

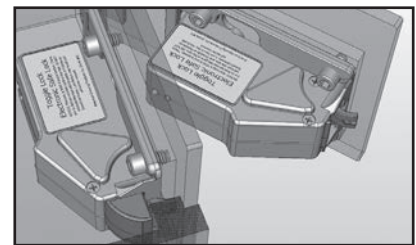

TOGGLE LOCK

**ESL5 AND ESL15**

AMSEC is a pioneer in the electronic lock market, and the **ESL5 AND ESL15 ELECTRONIC LOCKS** offer unrivaled value in electronic safe access. The ESL5 and ESL15 locks have the best blend of features and function in electronic safe locks. The ESL5 offers attractive chrome or black rubberized finish ABS housing with a backlit alphanumeric keypad. The ESL15 offers durable black rubberized finish ABS housing with an alphanumeric keypad. The ESL5 is a basic keypad lock for home and office applications. The ESL15 offers advanced features necessary for commercial applications.



**ESL5 & ESL15 FEATURES:**

- Replaces most mechanical combination locks. Easy installation and operation.
- U.L. Listed ESL5 has an attractive chrome or black rubberized finish ABS housing with a backlit alphanumeric keypad.
- ESL15 (U.L. Listing Pending) has a durable black rubberized finish ABS housing with an alphanumeric keypad.
- Factory Reset Combination for resolving lost combinations without requiring expensive service calls.
- Electronics are encapsulated within the lock and are sealed to prevent possible moisture-related failures.
- Cable fits through a 1/2" spindle hole without cutting and re-crimping connector.
- Beep and flash from every keystroke gives maximum feedback to the user.
- Lock can be programmed to silence the beep in stealth mode.
- 15-Minute Penalty Lockout after four incorrect entries protects against manipulation attempts.
- New swing bolt reversible lock design for right- or left-handed installation.
- Lock "auto-locks" when boltwork is thrown to prevent safes from being left in a day-lock position.

- One 9-volt battery can be easily replaced in the keypad housing.

**ESL15 ADDITIONAL FEATURES:**

- Time Delay Mode allows delay to be set from 1 to 99 minutes.
- Armored Car Override allows an armored car service to bypass Time Delay.
- Multiple User Mode allows for one master code and eight user codes to be used for full supervisory control and code management.
- Dual Control Mode programs the lock to require two combinations to open.





**AMSEC ESLXL SERIES**

**ELECTRONIC LOCKS**



**ESL10XL  
WITH CHROME FINISH**

**ESL10XL  
FEATURES:**

- Replaces most mechanical combination locks. Easy installation and operation.
- Factory Reset Combination for solving lost combinations without requiring expensive service calls.
- Electronics are encapsulated within the lock and are sealed to prevent possible moisture related failures.
- Cable fits through a 1/2" spindle hole without cutting and re-crimping connector.
- Audible beep and flash from every keystroke gives maximum feedback to the user.
- 15 minute Penalty Lockout after four incorrect entries protects against manipulation attempts.
- New patented dead-latched lock design with an internal relock device for maximum security.
- Lock "auto-locks" when boltwork is thrown to prevent safes from being left in a day lock position.
- Slam Bolt version for locker applications.
- Optional internal battery pack extends operation between battery changes.

AMSEC has been a pioneer in the electronic lock market. The **ESLXL SERIES** locks offer unrivaled value in electronic safe access. The ESL10XL and ESL20XL locks have the best blend of features and function in Electronic Safe Locks. The ESLXL SERIES offer an attractive metal die-cast keypad housing with an alpha-numeric slanted keypad. The ESL10XL is a basic keypad lock for home and office applications. The ESL20XL offers advanced features necessary for commercial applications.

**ESL20XL  
ADDITIONAL FEATURES:**

- Time Delay Mode: Delays can be set from 1 to 99 minutes.
- Multiple User Mode: When enabled, one Master code and eight user codes are available with full supervisory control and code management.
- Dual Control Mode: The lock can be programmed to require two combinations to open for added security.
- Armored Car Override: When enabled, allows an armored car service to bypass Time Delay.
- External A/C Power: Provides power for unlimited use with battery power as backup.
- Control Port: Turn the ESL20XL on/off with an Alarm System or other device.

**Optional Expansion Modules:**  
Provides these additional capabilities on the ESL20XL:

- Duress (Silent Signal) Alarm Output. Provides relay output for alarm system connection.
- External connection for A/C power transformer on ESL20XL and ESL10XL.
- External connection for control port.
- Provides for connection of one or two ESL20XL locks.



**ESL20XL  
WITH BLACK FINISH**

All the ESL20XL features are programmed from the keypad. The Expansion Modules provide convenient screw terminal and slip spade connections for field wiring by the installer.

A/C Power can be connected to the ESL10XL and ESL20XL lock (with the ESLAC kit) or an Expansion Module (with the ESLTFMR kit). Wiring, conduit and attachment hardware is provided with all optional kits.

Model	Description	Finish
ESL10XL	ESL10XL Standard Lock	Black Nickel, Chrome, Brass
ESL10XL-S	ESL10XL Slam Bolt Lock	Black Nickel, Chrome, Brass
ESL20XL	ESL20XL Standard Lock	Black
ESL20XL-S	ESL20XL Slam Bolt Lock	Black

\* Lock factory installed in place of the standard Mechanical Combination Lock, Dial and Dial Ring.  
 \*\* Lock factory installed as an auxiliary lock, includes all mount pads and hardware for installation.  
 Please refer to our Retail Price List for a complete list of part numbers for primary lock, auxiliary lock and Retrofit kit options.

Accessory Number	Description
ESLBAT	Aux. Battery pack for any ESL Locks. Provides extended life on battery power.
ESL20XLEXP1	Expansion Kit for (1) ESL20XL lock. External box with duress capability.
ESL20XLEXP2	Expansion Kit for (2) ESL20XL locks. External box with duress capability.
ESLAC	A/C Power kit for use with any ESL lock. Provided with conduit and fasteners.
ESLTFMR	A/C Transformer for use with any Expansion Kit.

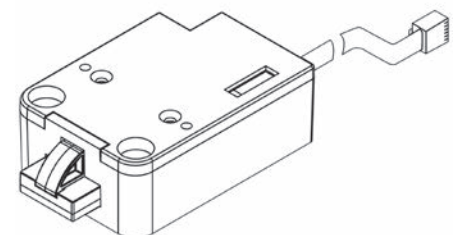

**SLAM BOLT**

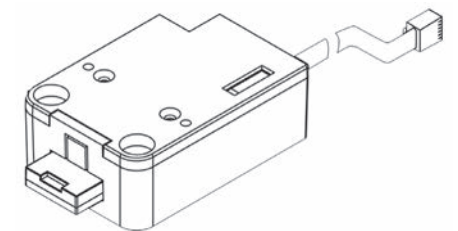

**STANDARD BOLT**

**ROTOBOLT REDUNDANT SAFE LOCK**



**The new U.L. Listed LP Lock offers the convenience of an Electronic lock and the trusted reliability of a mechanical combination lock.**

**Electronic Keypad and Mechanical Dial**

- Bright chrome finish
- Audible and visual feedback
- Durable Mylar keypad
- Spy-proof digital entry
- Sliding door access to battery compartment

**Electronic Lock**

- U.L. Type 1
- 1 Manager and 1 User code
- 6 Digit changeable code
- Time Delay (1 to 99 minutes)
- Battery low indicator
- Manipulation protection

**Mechanical Lock**

- U.L. Group 2M
- Manipulation resistant
- Standard mechanical lock footprint
- No spline key required

**Compatibility**

**Note:** This lock is not reversible and will only mount on right swing – vertical down or left swing – vertical up locking systems. For compatibility information, see: [amsec.fyi/rotobolt](http://amsec.fyi/rotobolt).



**LOCKS FROM S&G, KABA AND LAGARD**



**SARGENT AND GREENLEAF**  
A lock on security.



S&G Titan™



AUDITCON®  
ROUND PROFILE



LG BASIC II

**AMSEC offers a variety of locks from manufacturers like S&G., Kaba and LaGard. Please see AMSEC's Pricebook or talk to your local AMSEC sales representative for more information on what locks are available on AMSEC safes.**



**MECHANICAL LOCKS AND KEY LOCKS**



AMSEC offers a wide variety of options not listed here. Consult your AMSEC price book or call for other available options. AMSEC's staff will also assist in helping you choose the correct options for your security needs.



**U.L. Listed Group 2 Mechanical Combination Safe Lock Kit**

Mechanical Combination Safe Locks have been around for over 100 years and are very secure and reliable. With the proper care and service, the AMSEC mechanical combination safe lock will last a long time.

**Features:**

- Three brass and aluminum combination wheels provide 1,000,000 theoretical combinations.
- Dual brass locking cams prevent wheel slippage.
- Solid brass locking bolt and zinc drop lever.
- Four-way brass drive cam allows mounting RH, LH, VU or VD.
- Internal spring-loaded brass relock trigger guards against punch attacks.
- Standard mounting footprint matches most mechanical and electronic safe locks.
- Large front-read convertible dial and ring.
- Both dial and ring are die cast with black finish and white letters.
- A solid, machined brass spindle – 4 7/8"
- Can be converted to a key-locking dial with a disc tumbler key cylinder and two keys (shown at right).
- Comes standard with an attractive self-stick solid dial insert or a key-locking dial insert.

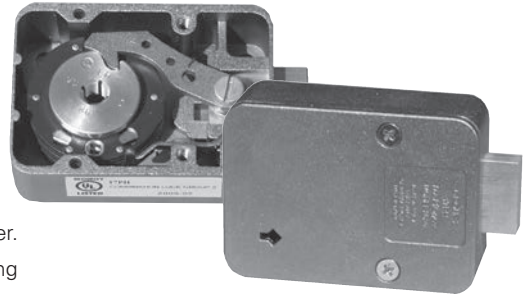

**Safe Lock Kit Includes:**

- U.L. Listed Group 2 mechanical safe lock.
- Large front-read convertible dial & ring, B/W finish.
- Non-key-locking dial insert.
- Key-locking dial insert.
- Key cylinder and two keys.
- Package mounting hardware and two spline keys.
- Combination change key.
- Durable packaging and foam inserts protect contents from shipping damage.



**Spyproof Dial**

Restricts unauthorized viewing while dialing combination. Also available with key locking feature.



**Key Locking Front Read Dial**

Key is used to lock dial in a fixed position and affords dual custody control. Manager has the combination, collector has the key. Both must be present to unlock the safe.



**144 Hour Time Lock**

Safes equipped with Time Locks offer the capability of locking the safe for a pre-selected period of time. Time periods range from one hour to 144 hours (6 full days).

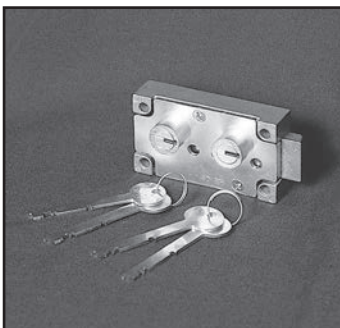

**U.L. Listed Dual Nose Key Lock**

Dual control safe deposit lock requires two different keys to open safe.

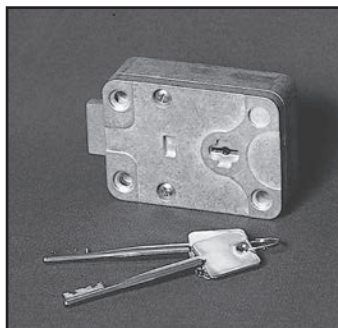

**U.L. Listed Key Op Lock**

European style seven-lever changeable key lock offers exceptional security features for use on inner locker or outer safe doors.

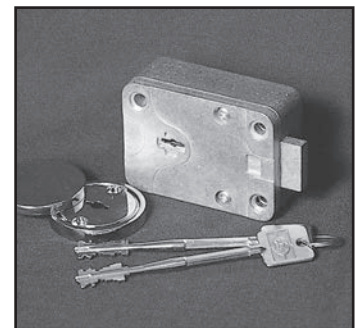

**U.L. High Security Key Lock**

European style nine-lever changeable key lock offers exceptional security features for use on inner locker or outer safe doors.



**MERCHANDISING / DISPLAYS**

MERCHANDISING / DISPLAYS



**3-PACK DISPLAY  
PART #1045008**



**DISPLAY PEDESTAL  
PART #1045014**



**BF® SAFE BODY  
CUTAWAY  
PART #1045223**



**BF® SAFE DOOR  
CUTAWAY  
PART #1045058**



**SALES BANNER - 5FT W X 3FT H  
PART #1045000**



**MAGNETIC PRICE  
TAGS (PACK OF 6)  
PART #1045004**



**SAFE USAGE POSTER  
(24"W X 18"H)  
PART #1045073**

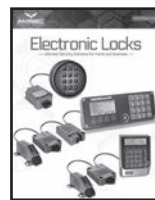

**ELECTRONIC LOCK  
BROCHURE  
PART #4305365**



**GUN SAFE  
CATALOG  
PART #4305172**



**PRODUCT  
CATALOG  
PART #1045129**



**RETAIL  
PRICE LIST  
PART #4305127**



**CONSUMER PRODUCTS  
BROCHURE  
PART #4305128**



**"BURGLARY / FIRE SAFES"  
HANGING SIGN (21" W X 10" H)  
PART #1045024**

**AMSEC PROMO PACKS**

PART #	DESCRIPTION
1045008	3-PACK SAFES: WS1014, WFS149E5LP, & WS1214E5 Also includes display stand, POP, product tags, color poster and consumer brochures.
1045020	4-PACK PROMOTIONAL KIT: safe pedestal, sales banner, 3 hanging signs, safe usage poster, window decal, consumer brochures & product tags.
1045021	8-PACK PROMOTIONAL KIT: Two safe pedestals, sales banner, 4 hanging signs, safe usage poster, window decal, consumer brochures & product tags.

**AMSEC INDIVIDUAL SALES AIDS**

PART #	DESCRIPTION	PRICE
1045014	Display Pedestal	\$170
1045000	Sales Banner (5ft w x 3ft h)	\$40
1045024	"Burglary/Fire Safes" Hanging Sign (21"w x 10"h)	\$15
1045028	"Fire Safes" Hanging Sign (21"w x 10"h)	\$15
1045029	"Floor Safes" Hanging Sign (21"w x 10"h)	\$15
1045030	"Depository Safes" Hanging Sign (21"w x 10"h)	\$15
1045134	"Wall Safes" Hanging Sign (21"w x 10"h)	\$15
1045133	"Gun Safes" Hanging Sign (21"w x 10"h)	\$15
1015241	Authorized Dealer Window Decal	\$10
1045073	Guide to Safe Usage Poster (24"w x 18"h)	\$0
4305127	Retail Price List	\$0
4305128	Guide to All Products Brochure (color 4 x 9)	\$0
1045129	Dealer Catalog	\$0
4305172	Gun Safe Brochure	\$0
1045072	Gun Safe Warranty Poster (24"w x 18"h)	\$0
1045076	BF® Gun Safe Authorized Dealer Banner (5ft w x 3ft h)	\$40
1045058	BF® Door Cutaway Plaque	\$75
1045223	BF®/BFHD Body Cutaway Plaque	\$210
4305174	Warranty/Operating Booklet	\$0
1045004	Magnetic Price Tags (4 x 6) - Pack of 6	\$20
1045007	3 pack display only	\$170
4305365	Electronic Locks Dealer Brochure	\$0
1045019	Plexiglass Brochure Holder	\$0

# GUIDE TO SAFE USAGE

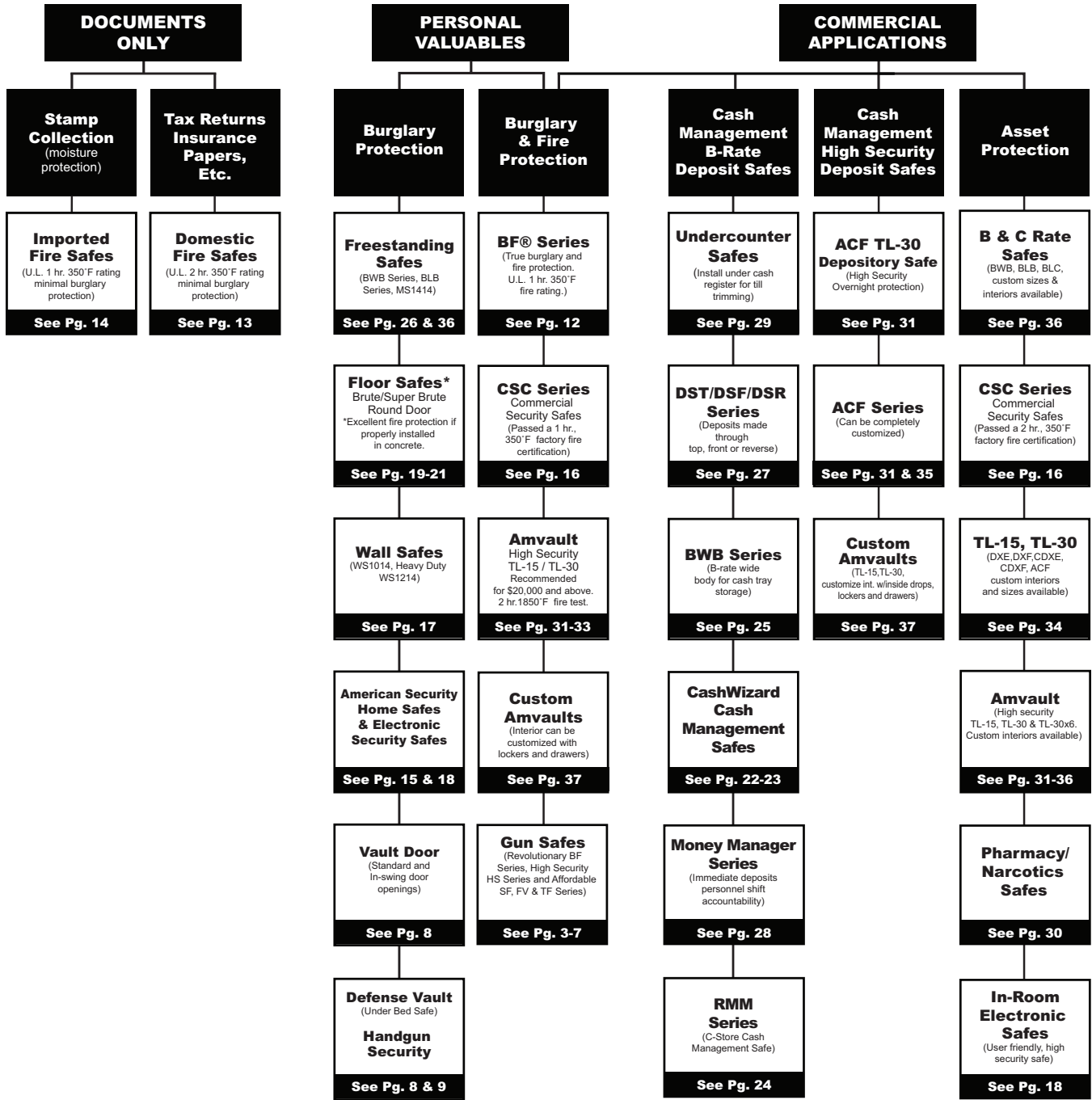

**Have a Twitter or Facebook account?  
Follow us on Twitter and Like Us on Facebook for  
AMSEC news, product announcements and more!  
Scan the QR codes below**





**INDEX BY MODEL NUMBER**

**INDEX BY MODEL NUMBER**

**A**

ACF 2020 ..... 35

ACF 2020XD ..... 35

ACF 3020 ..... 35

ACF 3020XD ..... 35

ACF 4024 ..... 35

ACF 4024XD ..... 35

ACF4824DS ..... 31

ACF 5024 ..... 35

ACF 5024XD ..... 35

ACF 6030 ..... 35

ACF 6030XD ..... 35

AM2020E5 ..... 14

AM3020E5 ..... 14

AM4020E5 ..... 14

**B**

B6 ..... 21

B17 ..... 21

B24 ..... 21

B1500 ..... 19

B1806 ..... 19

B1810 ..... 19

B1816 ..... 19

B1816D ..... 19

B2200 ..... 19

B2900 ..... 19

B3700 ..... 19

B3800 ..... 19

B5800 ..... 19

BD24 ..... 21

BDP24 ..... 21

BF1512 ..... 12

BF1716 ..... 12

BF2116 ..... 12

BF3416 ..... 12

BF6024 ..... 4

BF6024HD ..... 4

BF6030 ..... 4

BF6030HD ..... 4

BF6032 ..... 4

BF6032HD ..... 4

BF6636 ..... 4

BF6636HD ..... 4

BF7240 ..... 4

BF7240HD ..... 4

BF7250 ..... 4

BF7250HD ..... 4

BFS912E5LP ..... 14

BLB2018 ..... 36

BLB3018 ..... 36

BLB3024 ..... 36

BLB4024 ..... 36

BLC2018 ..... 36

BLC3018 ..... 36

BLC3024 ..... 36

BLC4024 ..... 36

BR2012 ..... 22

BR2013 ..... 22

BR3113 ..... 22

BR3119 ..... 22

BR3120 ..... 22

BWB2020 ..... 27

BWB2020-D1 ..... 26

BWB2020FL ..... 26

BWB2020FLNL ..... 26

BWB2020FLR ..... 26

BWB2020FLRNL ..... 26

BWB2025 ..... 27

BWB2025FL ..... 26

BWB2025FLR ..... 26

BWB3020 ..... 27

BWB3020-D1 ..... 26

BWB3020FL ..... 26

BWB3020FLR ..... 26

BWB3025 ..... 27

BWB3025FL ..... 26

BWB3025FLR ..... 26

BWB4020 ..... 27

BWB4020FL ..... 26

BWB4020FLR ..... 26

BWB4025 ..... 27

BWB4025FL ..... 26

BWB4025FLR ..... 26

**C**

C3 ..... 20

C5 ..... 20

C7 ..... 20

CD5 ..... 20

CD7 ..... 20

CDXE ..... 34

CDXF ..... 34

CE1814 ..... 33

CE2518 ..... 33

CE3524 ..... 33

CE4524 ..... 33

CE5524 ..... 33

CE6528 ..... 33

CE7236 ..... 33

CF1814 ..... 33

CF2518 ..... 33

CF3524 ..... 33

CF4524 ..... 33

CF5524 ..... 33

CF6528 ..... 33

CF7236 ..... 33

CFX252016 ..... 31

CFX352020 ..... 31

CFX452020 ..... 31

CFX582820 ..... 31

CFX703620 ..... 31

CSC1413 ..... 13

CSC1913 ..... 13

CSC3018 ..... 13

CSC4520 ..... 13

**D**

DSC2014KC ..... 28

DSF2014 ..... 28

DSF2516E2 ..... 25

DSF2714 ..... 28

DSF3214 ..... 28

DSR2014 ..... 28

DSR2516E2 ..... 25

DST2014 ..... 28

DST2714 ..... 28

DST3214 ..... 28

DV652 ..... 8

DXE ..... 34

DXF ..... 34

**E**

ESF1214 ..... 15

ESL5 ..... 40

ESL10XL ..... 41

ESL15 ..... 40

ESL20XL ..... 41

ESLAUDIT ..... 40

EST813 ..... 15

EST916 ..... 15

EST1014 ..... 15

EST2014 ..... 15

**F**

FS149 ..... 17

FS149E5LP ..... 17

FS712E5LP ..... 17

FS914 ..... 17

FS914E5LP ..... 17

FS1814E5 ..... 17

FV6030E5 ..... 6

FV6032E5 ..... 6

FV6036E5 ..... 6

FV7240E5 ..... 6

**H**

HAS410 ..... 9

**I**

IRC412 ..... 9

IRC916E ..... 15

**K**

K1 ..... 29

**L**

LG BASIC II ..... 42

**M**

MM2820Ctr-Drop-E15 25

MM2820Top-Drop-E1525

MM28203-Drop-E15 ..... 25

MS1414 ..... 27

**N**

NS2020 ..... 30

NS3020 ..... 30

NS4020 ..... 30

**P**

PB3 ..... 9

PDO ..... 11

PS1210EZ ..... 9

PS1210HD ..... 9

PSAUDIT ..... 30

PSE ..... 30

PSK ..... 30

PSSW ..... 30

**R**

RF6528 ..... 3

RF582820X6 ..... 3

RF703620X6 ..... 3

RMM2620ESL20-R ..... 24

RMM2620ESLAudit-R ..... 24

RMM2620SW-R ..... 24

RMM3124ESLAudit ..... 24

ROTOBOLT ..... 42

**S**

SAFE CLOAK ..... 11

STOR-IT CABINETS ..... 10

**T**

T425 ..... 21

T625 ..... 21

T625DD ..... 21

T925 ..... 21

T925DD ..... 21

TB0610 ..... 29

TF5517E5 ..... 7

TF5924E5 ..... 7

**U**

UL1511 ..... 16

UL1812 ..... 16

UL1812X ..... 16

UL2018 ..... 16

UL3918 ..... 16

**V**

VD8030BF ..... 8

VD8030BFIS ..... 8

VD8030NF ..... 8

VD8030NFIS ..... 8

VD8036BF ..... 8

VD8036BFIS ..... 8

VD8036NF ..... 8

VD8036NFIS ..... 8

**W**

WEST2114 ..... 18

WFS149 ..... 18

WFS149E5LP ..... 18

WS1014 ..... 18

WS1214E5 ..... 18



**PARCHMENT**



**ROMANESQUE GRAY**



**GRAY**



**BLUE GRAY**



**SATIN BLACK**



**CHARCOAL GRAY**

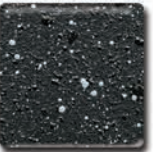

**GRANITE**

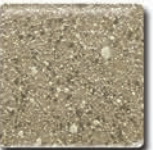

**SANDSTONE**



**CHOCOLATE BROWN**



**AMSEC is the world's leading producer of burglar resistant safes. Here's why:**

**Volume**

We produce over 60,000 safes each year! Whether you need one safe or one hundred, we can design and build a safe that meets your specifications and requirements.

**Manufacturing**

We are located in Fontana, California is just ten minutes from Ontario International Airport. In 1998, we expanded our factory to 150,000 sq. ft. to better serve your needs.

**Employees**

AMSEC employs a force of 400 to ensure timely design, manufacturing and delivery of quality safes.

**Underwriters Laboratories Ratings**

Our products lead the industry with multiple U.L. Listings in various categories.

**Round-the-clock- Customer Service**

Our customer service representatives are available to help 24 hours a day, 365 days a year. Just call our toll-free hotline.



**PLATINUM METALLIC**



**MACADAMIA METALLIC**



**BURGUNDY METALLIC**



**PEARL ESSENCE METALLIC**



**CHARCOAL METALLIC**



**ONYX**



**TWO-TONE COLORS**



**GRANITE / CHARCOAL METALLIC**



**BLACK / ONYX**

**MATTE COLORS**



**MATTE BLACK**



**ROSSO CORSA RED**